

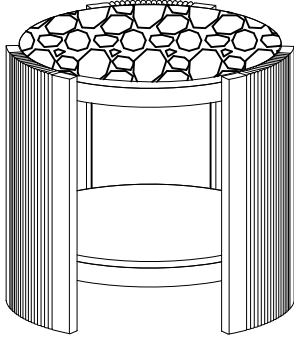





ASSEMBLY INSTRUCTION FOR ACME FURNITURE



MODEL# LV01503

Thank you for purchasing the quality product. Be sure to check all packing material carefully for small parts which may have come loose inside the carton during shipment. Separate, Identify and count all parts and metal hardware. Compare with all parts listed to be sure all parts are present. If any part(s) are missing or damaged, please contact your local furniture dealer. For efficient and speedy service, please indicate the model number and code letter of part(s) needed.

****Do not fully tighten screws until fully assembled****

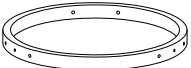
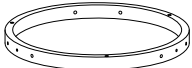

HARDWARE LIST:			
A		Ø5/16"x19mm	12 PCS
B		Ø5/16"	12 PCS
C		Ø5/16"x1-3/4"	12 PCS
D		4-1/4"x1-1/4"xØ6/32" Allen Wrench	1 PC
E		Wood dowel	6 PCS
F		Wood Screw Ø8x1"	3 PCS

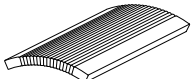
1  RING STRETCHER TOP 1 PC	2  RING STRETCHER SHELF 1 PC	3  BLUE STONE TOP 1PC	4  WOOD PANEL SHELF 1PC	5  SIDE POST LEGS 3 PCS
--	--	---	--	---

How to assemble & Steps

STEP 1

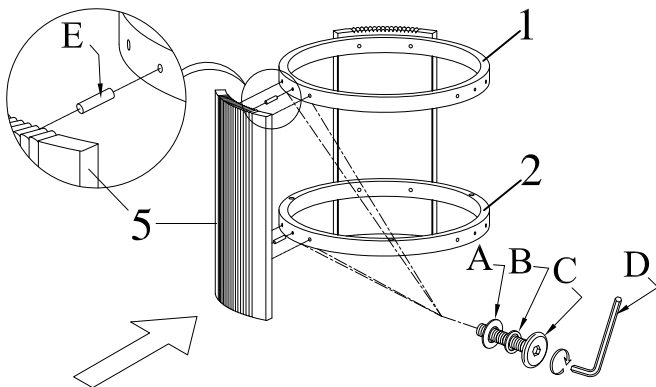

STEP 2

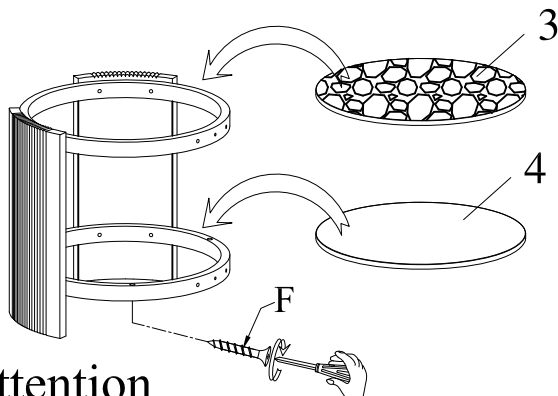

STEP 3

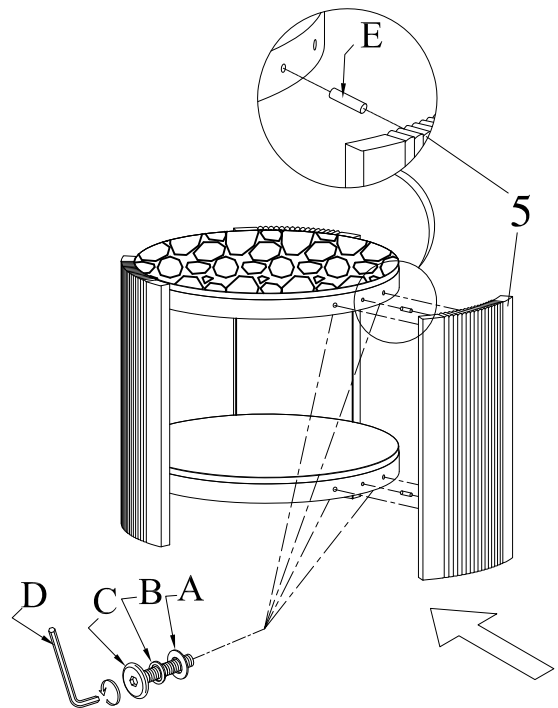

Attention

***Some number parts listed on the instruction sheet may not be in parts bag as they may be assembled. Carefully check parts and packing materials prior to ordering replacements. ***

CLEANING INSTRUCTIONS

Clean the surface with a furniture polish and a soft cloth