









ASSEMBLY INSTRUCTIONS FOR ACME FURNITURE







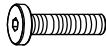

MODEL#BD02027Q1/Q2/Q3

Thank you for purchasing the quality product. Be sure to check all packing material carefully for small parts which may have come loose inside the carton during shipment. Separate, identify and count all parts and metal hardware. Compare with all parts list to be sure all parts are present. If any part(s) are missing or damaged, please contact your local furniture dealer. For efficient and speedy service, please indicate the model number and code letter of part(s) needed.

***** Do not fully tighten screws until fully assembled *****

COMPONENT PARTS			
No	PART NAME	PICTURE	Q'TY(PCS)
①	HEADBOARD		1
②	HEADBOARD POST		1R+1L
③	HEADBOARD SLAT		1
④	FOOTBOARD		1
⑤	BUN FOOT		2
⑥	BED RAIL		2
⑦	SLATRAIL		4
⑧	SUPPOR LEG		4

HARDWARE REQUIRED

A		BOLT	Ø5/16"*1-3/4"	8 PCS
B		LOCK WASHER	Ø5/16"	16 PCS
C		FLAT WASHER	Ø5/16"*20mm	8 PCS
D		ALLEN KEY	Ø5/16"	1 PC
E		BOLT	Ø5/16"*3-1/2"	8 PCS
F		NUT	Ø5/16"	8 PCS
G		HALF MOON WASHER	Ø5/16"	8 PCS
H		WRENCH	12mm	1 PC
I		SCREW	#8"*1-1/4"	8 PCS

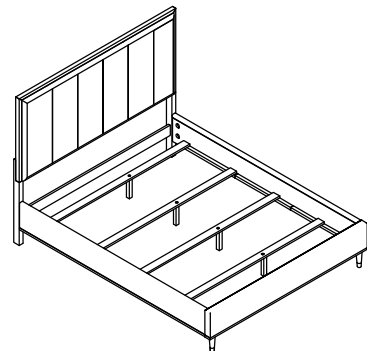

Attention

*** Some number parts listed on the instruction sheet may not be in parts bag as they may already be assembled. Carefully check parts and packing materials prior to ordering replacements.

How to assemble:

STEP 1

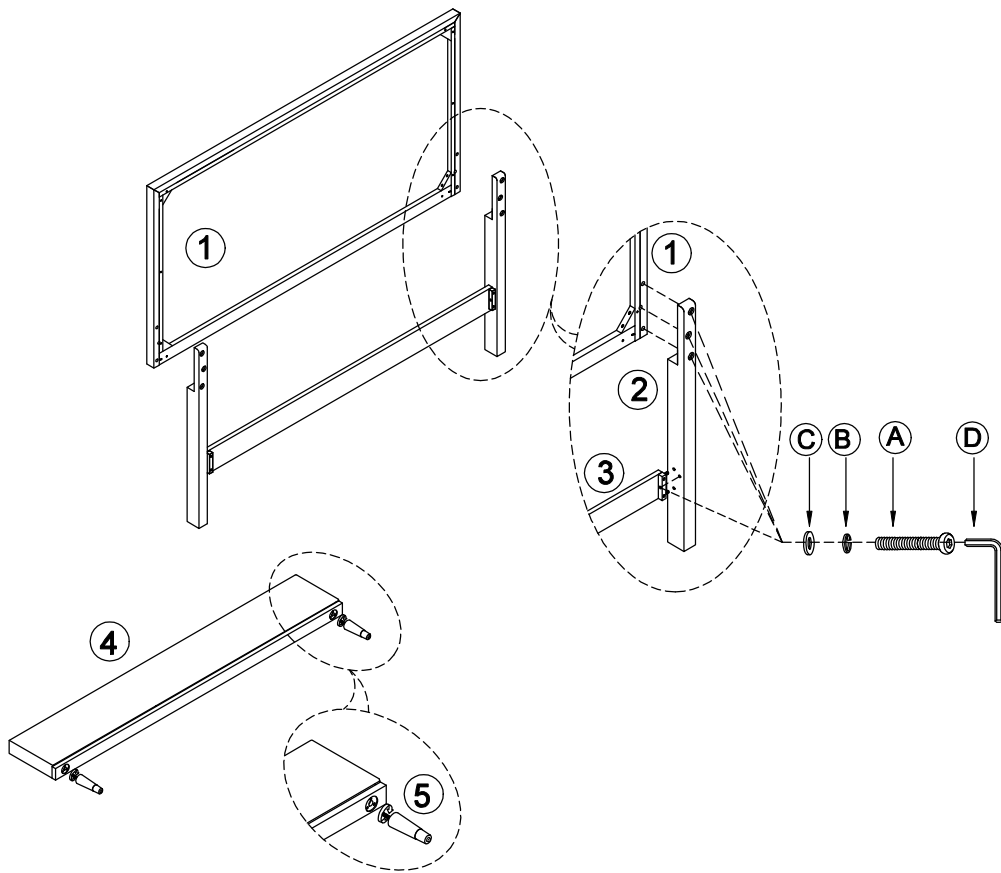

STEP 2

