

ASSEMBLY INSTRUCTION FOR ACME FURNITURE

MODEL #BD01474EK1





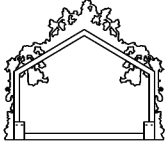
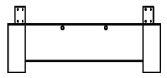

Thank you for purchasing the quality product. Be sure to check all packing material carefully for small parts which may have come loose inside the carton during shipment. Separate, identify and count all parts and metal hardware. Compare with all parts list to be sure all parts are present. If any part(s) are missing or damaged, please contact your local furniture dealer. For efficient and speedy service, please indicate the model number and code letter of part(s) needed.

***** Do not fully tighten screws until fully assembled *****

PARTS LIST

NO	DESCRIPTION	SKETCH	QTY
A	HEADBOARD		1 Pcs
B	BASE		1 Pcs

HARDWARE LIST

NO	DESCRIPTION	SKETCH	QTY
1	BOLT (Ø5/16*50MM)		8 Pcs
2	FLAT WASHER (Ø5/16*2MM)		8 Pcs
3	ALLEN KEY (M4)		1 Pcs
4	SCREW BOLT (Ø5/16*100MM)		2 Pcs
5	TIGHT FIRMWARE		2 Pcs
6	HEXAGON NUT		2 Pcs
7	WRENCH		1 Pcs

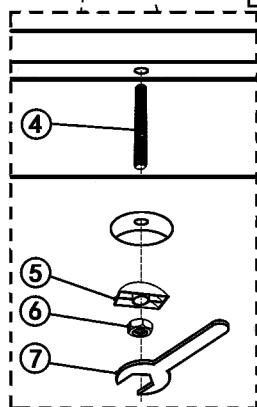
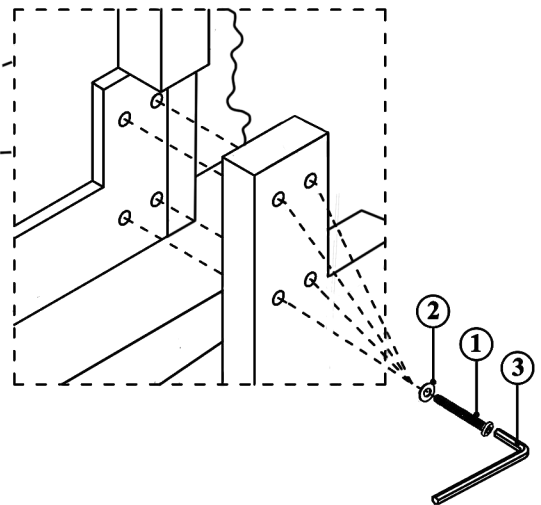
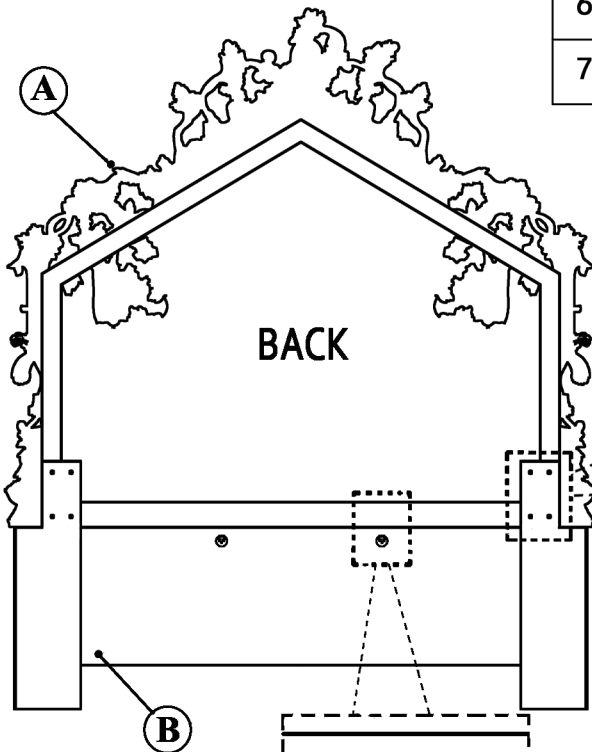

MADE IN CHINA





COMPLETED



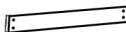
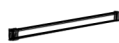

ASSEMBLY INSTRUCTION FOR ACME FURNITURE

MODEL #BD01474EK

Thank you for purchasing the quality product. Be sure to check all packing material carefully for small parts which may have come loose inside the carton during shipment. Separate, identify and count all parts and metal hardware. Compare with all parts list to be sure all parts are present. If any part(s) are missing or damaged, please contact your local furniture dealer. For efficient and speedy service, please indicate the model number and code letter of part(s) needed.

***** Do not fully tighten screws until fully assembled *****

PARTS LIST			
NO	DESCRIPTION	SKETCH	QTY
A	HEADBOARD		1 Pc
B	FOOTBOARD		1 Pc
C	RAILS		2 Pcs
D	SLATS		5 Pcs
E	BED CORNER FIXING PLATE		4 Pcs

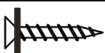
HARDWARE LIST			
NO	DESCRIPTION	SKETCH	QTY
1	SCREW BOLT(Ø5/16*100MM)		8 Pcs
2	TIGHT FIRMWARE		8 Pcs
3	HEXAGON NUT		8 Pcs
4	ALLEN WRENCH		1 Pcs
5	LONG SCREW(7MM*20MM)		16 Pcs

STEP 1 ~ STEP 2

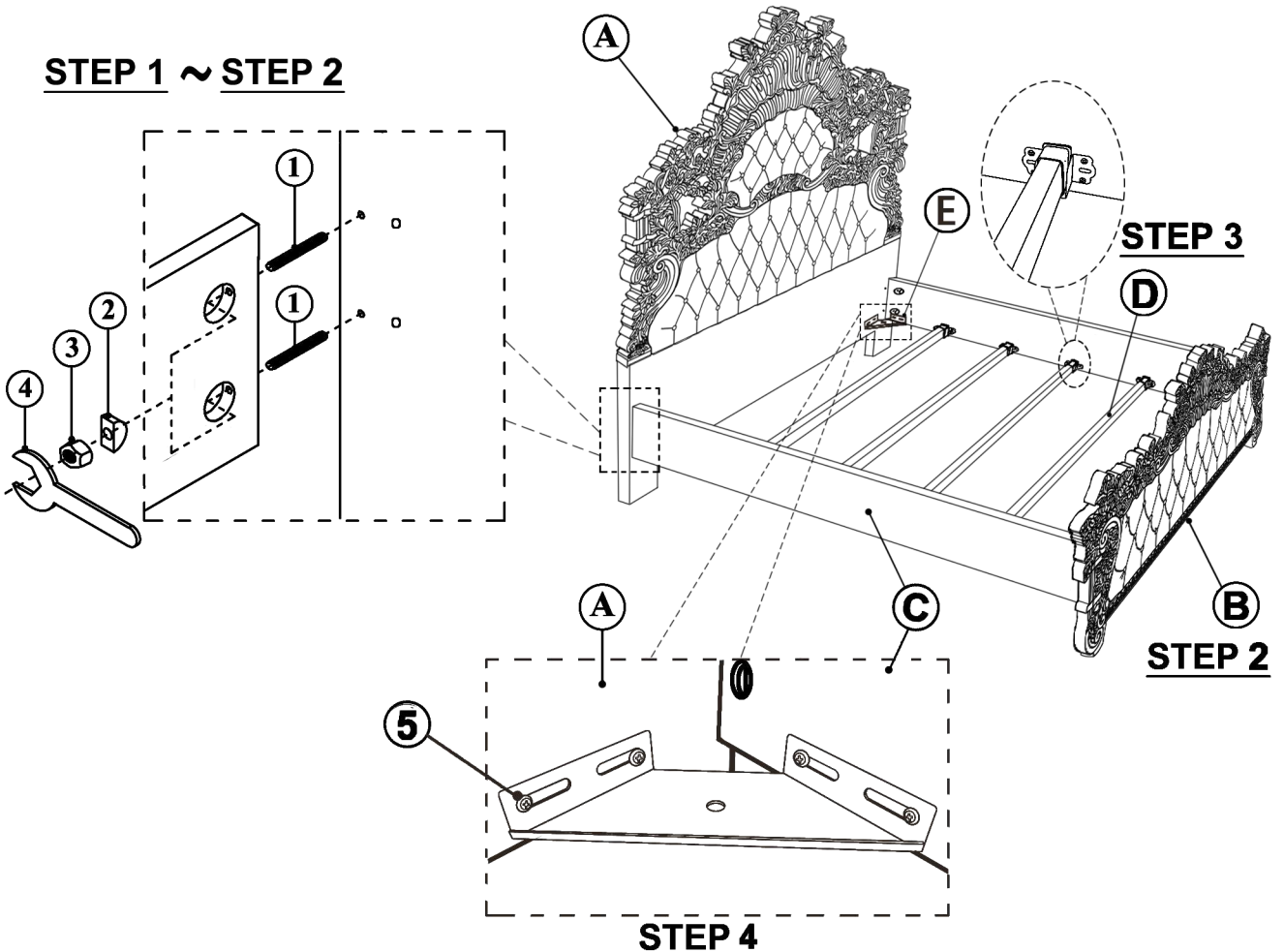

Made in China

COMPLETED