

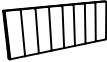



















ASSEMBLY INSTRUCTION FOR ACME FURNITURE MODEL # BD00571Q

Thank you for purchasing the quality product. Be sure to check all packing material carefully for small parts which may have come loose inside the carton during shipment. Separate, identify and count all parts and metal hardware. Compare with all parts list to be sure all parts are present. If any part(s) are missing or damaged, please contact your local furniture dealer. For efficient and speedy service, please indicate the model number and code letter of part(s) needed.

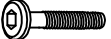
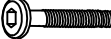
Do not fully tighten screws until fully assembled

COMPONENT PARTS			
	DESCRIPTION	PART NAME	Q'TY (PCS)
①	HEADBOARD		1
②	FOOTBOARD		1
③	HEADBOARD LEG (LEFT)		1
④	HEADBOARD LEG (RIGHT)		1
⑤	HEADBOARD LEG BLOCK		2
⑥	SIDE RAIL (A) LEFT		1
⑦	SIDE RAIL (B) LEFT		1
⑧	SIDE RAIL (A) RIGHT		1
⑨	SIDE RAIL (B) RIGHT		1
⑩	BED FOOTBOARD LEG LEFT		1
⑪	BED FOOTBOARD LEG RIGHT		1
⑫	BED SLAT (X6)		2 SETS
⑬	SIDE RAIL LEG		2
⑭	BED SLAT SUPPORT		4
⑮	BED CENTER SLAT		2

HARDWARE REQUIRED(BOX OF HEADBOARD)

- (A)  BOLT 1/4" x 1 3/8" - 16 PCS
- (B)  BOLT 1/4" x 2" - 8 PCS
- (C)  SPRING WASHER 1/4"- 20 PCS
- (D)  FLAT WASHER 1/4" - 20 PCS
- (E)  FLATHEAD CHIPBOARD SCREW 5/32" x 1" - 24 PCS
- (F)  WOOD DOWEL 1/4" x 1 3/16" - 4 PCS
- (G)  ALLEN KEY M4 x 4 5/16"- 1 PC
- (H)  ALLEN KEY M5 - 1 PC

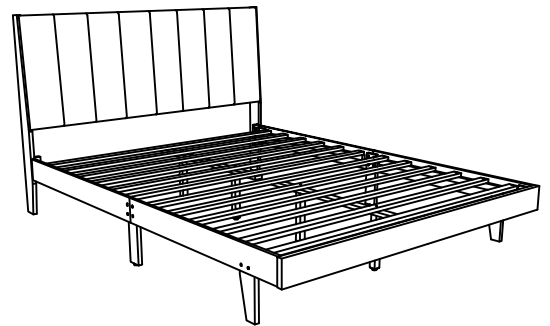

Attention:

*** Some number parts listed in the instruction sheet may not be in parts bags as they already be assembled. Caerfully check parts and packing materials prior to ordering replacements.

How to assemble:

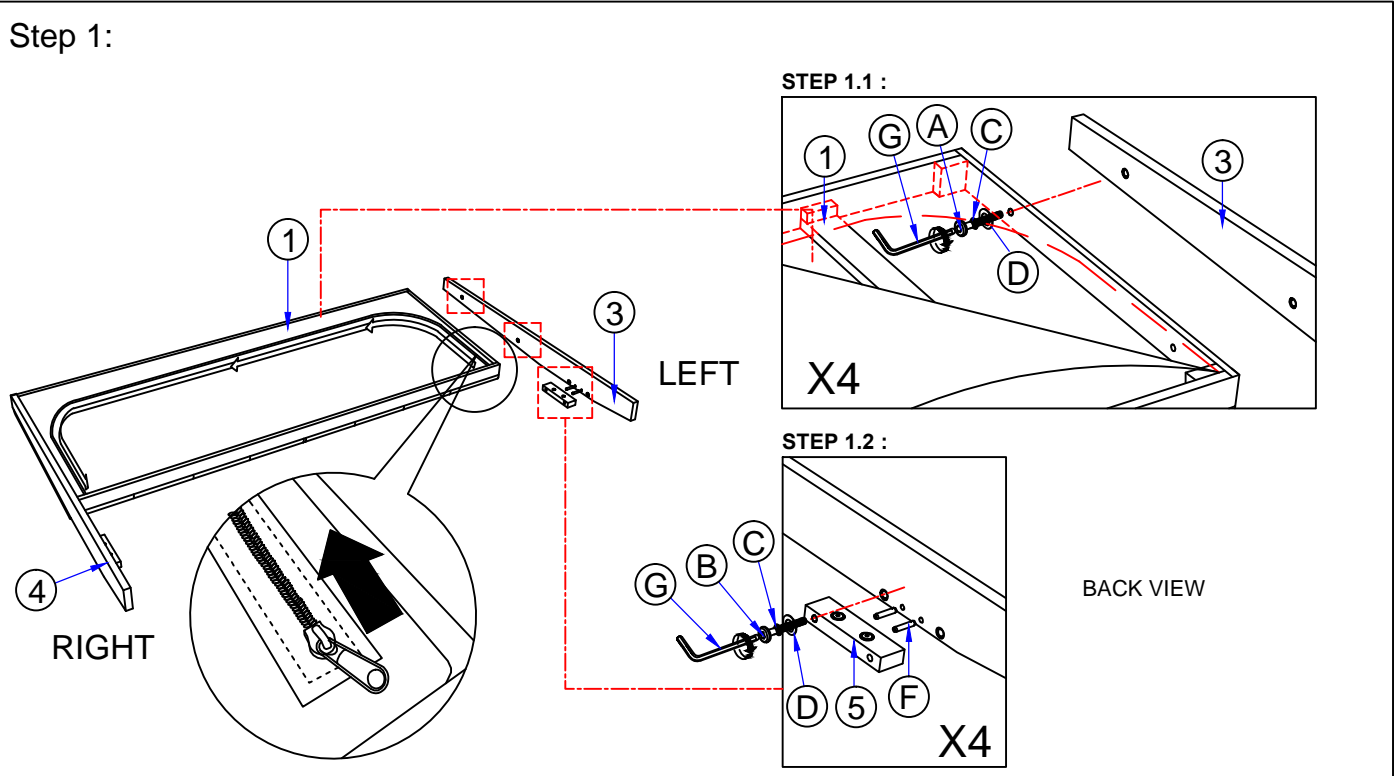

How to assemble:

Step 2:

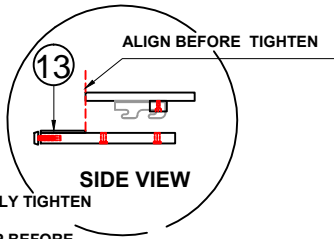

DO NOT FULLY TIGHTEN SCREW IN THIS STEP BEFORE ALIGN THE SIDE RAIL AS SHOWN.

X12

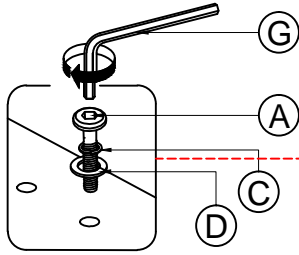

SIDE RAIL LEFT POSITION

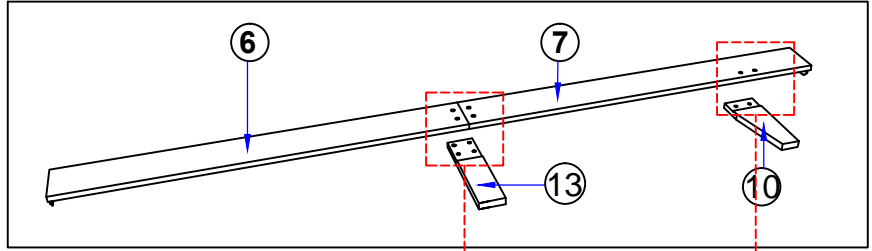

SIDE RAIL RIGHT POSITION

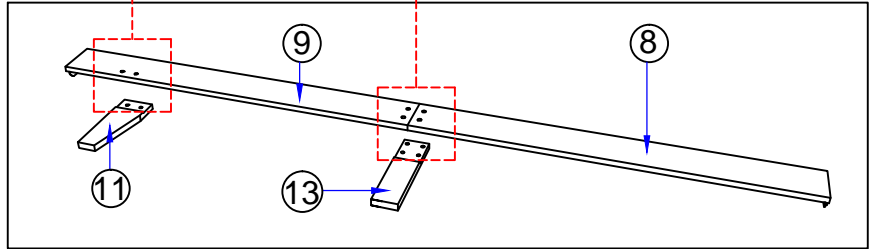

Step 3:

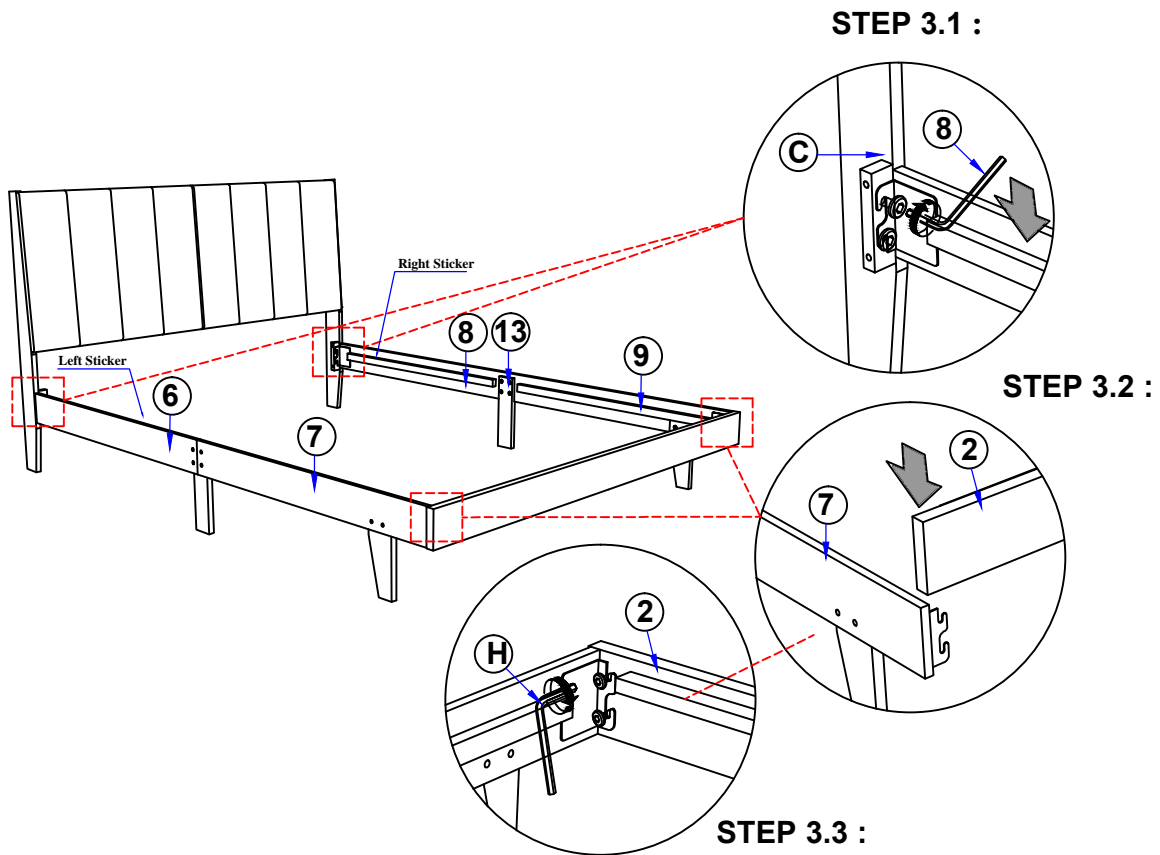

How to assemble:

Step 4:

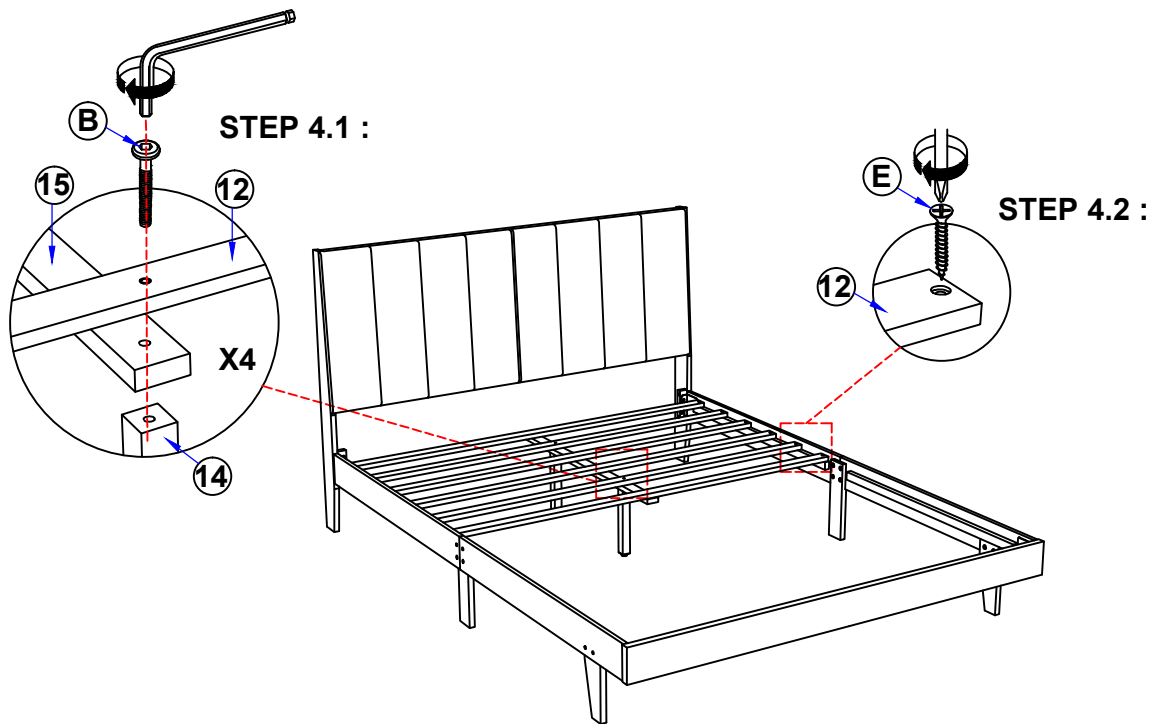

Step 5:
COMPLETE

