

# ASSEMBLY INSTRUCON FOR ACME FURNITURE

## MODEL ITEM NO:98180





Thank you for purchasing this quality product. Be sure to check all packing materlai carefully for small parts which may have come loose Inside the carton during shlpment. Sepaeate, identify and count all parts and metal hardware. Compare with parts list to be surre all parts sre present. If any parts are missing or damaged, please contact your local fumlture dealer. For efficient and speedy service, please indicate the model number and code letter df parts needed.

**\*\*\* Do not fully tighten screws until fully assembled \*\*\***

### COMPONENT PARTS

| DESCRIP TION | PART NAME    | Q' TY (PCS) |
|--------------|--------------|-------------|
| ①            | Cabinet body | 1           |
| ②            | Castor       | 4           |

### HARDWARES REQUIRED

|   |   |                        |        |
|---|---|------------------------|--------|
| Ⓒ |  | Screw 5/16"*1"         | 16 PCS |
| Ⓓ |  | Lock 5/16"             | 16 PCS |
| Ⓔ |  | Flat Washer 5/16"*22mm | 16 PCS |
| Ⓕ |  | Allen Wrench 5mm       | 1 PCS  |

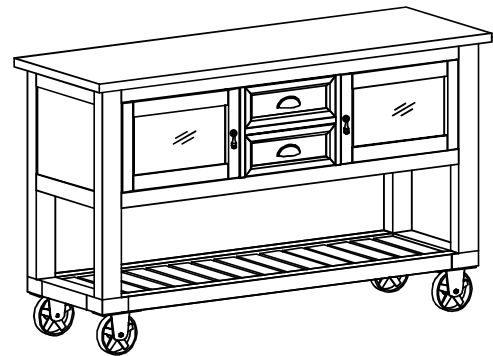

Attention:

\*\*\* Mattreses not inc luded.

\*\*\* Some number parts llsted on the instlon sheet mar not ba in pag as they may already be assembled

Carefully check pares and packing materials prior to odeing replacements

# ASSEMBLY INSTRUCON FOR ACME FURNITURE

## MODEL ITEM NO:98180

STEP 1

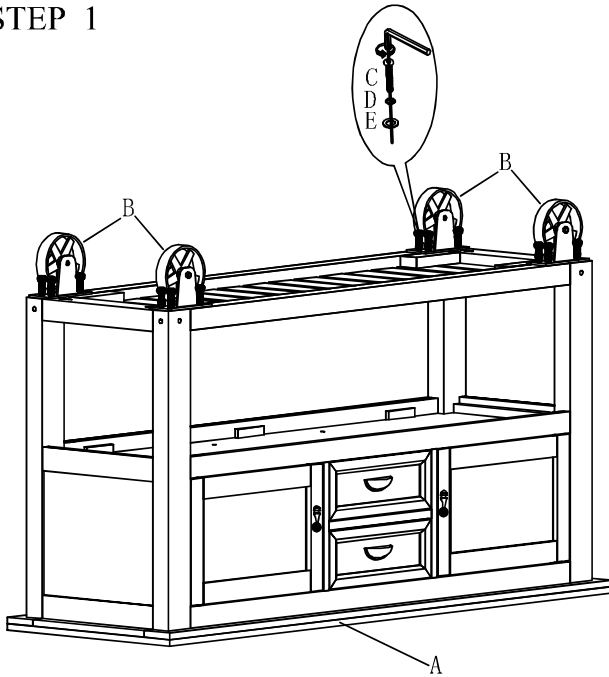

### PARTS LIST:

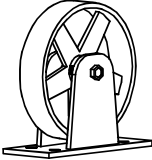
| NO | Description  | Sketch  | Quantity |
|----|--------------|---|----------|
| A  | Cabinet body |  | 1 PCS    |
| B  | Castor       |  | 4 PCS    |

STEP 2

