







ITEM NO. 92506/92507
OFFICE CHAIR

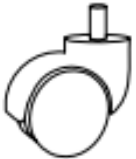
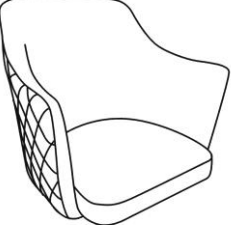

ASSEMBLY INSTRUCTIONS

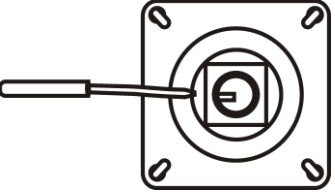
1	2	3
 <p>GAS LIFT 1PC</p>	 <p>SWIVEL BASE 1PC</p>	 <p>CASTER 5PCS</p>
4	5	6
 <p>SEAT 1PC</p>	 <p>BASE CAP 1PC</p>	 <p>BRACKET W/HANDLE 1PC</p>
A	B	
 <p>BOLT M6X1/2" 4PCS</p>	 <p>WRENCH 1PC</p>	

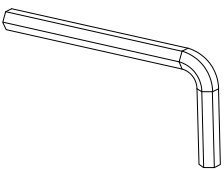
STEP 1

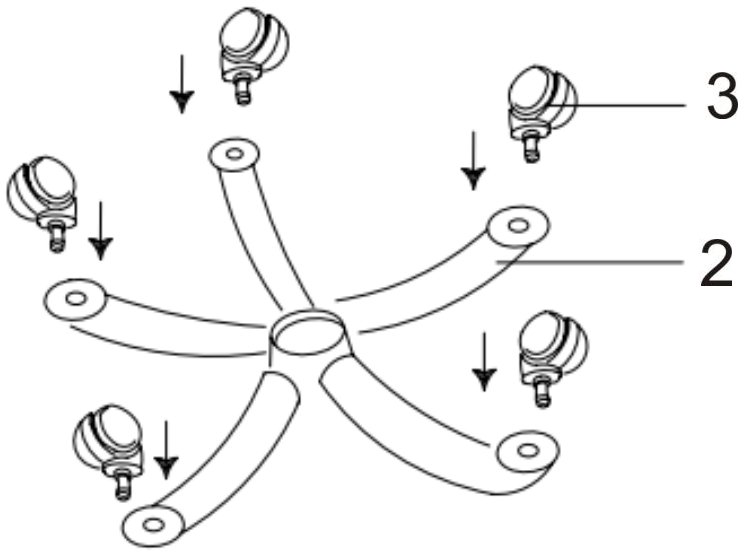

*Please put all parts on a soft surface to prevent scratches.

Insert Caster (3) into Swivel Base (2) carefully as shown.

STEP 2

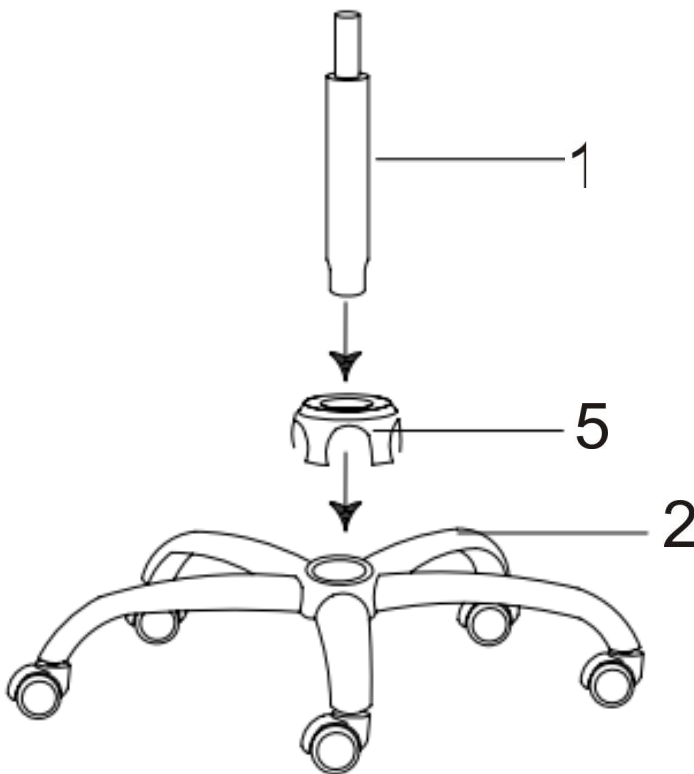

Insert Base cap (5) and Gas lift (1) into Swivel Base (2) carefully as shown.

STEP 3

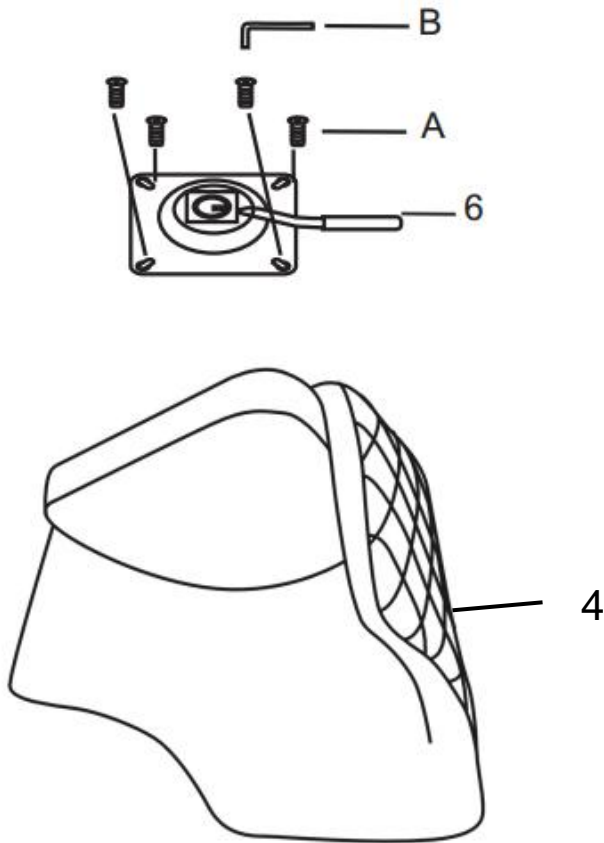

Attach Bracket w/Handle (6) to seat (4) by using bolt (A) and Wrench (B) as shown.

Tighten all bolts firmly!

STEP 4

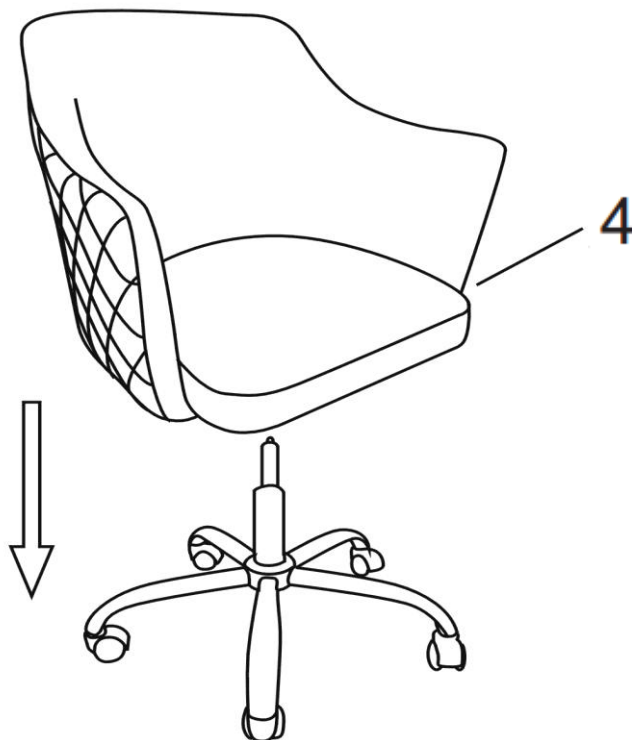

Insert Gas lift (1) into seat (4) by applying moderate downwards force to the seat (4) in order to secure it to the base as shown. Your perfect chair is completed.