

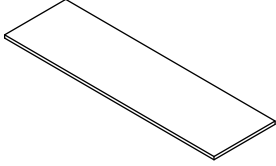

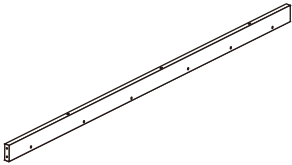

# ASSEMBLY INSTRUCTION FOR ACME RURNITURE

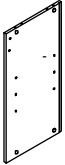

## MODEL# 91855 TV STAND

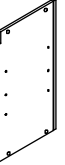

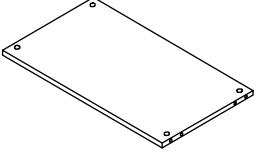
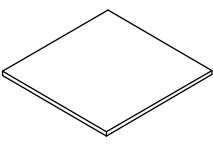



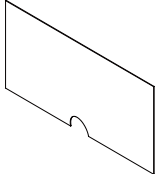
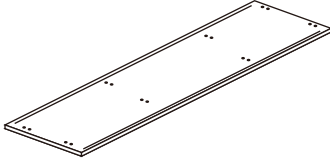
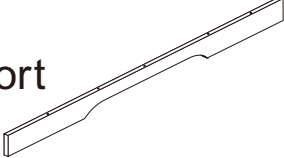
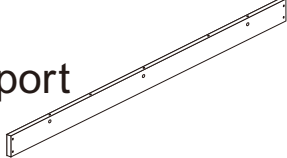
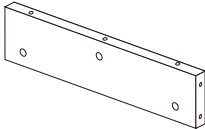
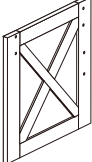

Thank you for purchasing this quality product. Be sure to check all packing materials carefully for small parts which may have come loose inside the carton during shipment. Separate, identify, and count all parts and metal hardware. Compare with parts list to be sure all parts are present. If any part(s) are missing or damaged, please contact your local furniture dealer. For efficient and speedy service, please indicate the model number and code letter of the part(s) needed.

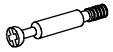







**\*\*\* Do not fully tighten screws until fully assembled \*\*\***

COMPONENT PARTS		
DECERPTION	PART NAME	Q'TY(PCS)
1	top 	1 PC
2	large top slat 	1 PC
3	left side panel 	1 PC
4	left divider panel 	1 PC
5	right divider panel 	1 PC
6	right side panel 	1 PC
7	middle fixed shelf 	1 PC
8	adjustable shelf 	2 PCS

## COMPONENT PARTS

DECERPTION	PART NAME	Q'TY(PCS)
<p style="text-align: center;"><b>9</b></p>	<p style="text-align: center;">side back panel</p> 	<p style="text-align: center;"><b>2PCS</b></p>
<p style="text-align: center;"><b>10</b></p>	<p style="text-align: center;">middle back panel</p> 	<p style="text-align: center;"><b>2PCS</b></p>
<p style="text-align: center;"><b>11</b></p>	<p style="text-align: center;">botom panel</p> 	<p style="text-align: center;"><b>1 PC</b></p>
<p style="text-align: center;"><b>12</b></p>	<p style="text-align: center;">front bottom support</p> 	<p style="text-align: center;"><b>1 PC</b></p>
<p style="text-align: center;"><b>13</b></p>	<p style="text-align: center;">back bottom support</p> 	<p style="text-align: center;"><b>1 PC</b></p>
<p style="text-align: center;"><b>14</b></p>	<p style="text-align: center;">side bottom support</p> 	<p style="text-align: center;"><b>2 PCS</b></p>
<p style="text-align: center;"><b>15</b></p>	<p style="text-align: center;">left sliding door</p> 	<p style="text-align: center;"><b>1 PC</b></p>
<p style="text-align: center;"><b>16</b></p>	<p style="text-align: center;">right sliding door</p> 	<p style="text-align: center;"><b>1 PC</b></p>

<b><u>HARDWARE REQUIRED:</u></b>		
<b>A</b> 	6*35	34 PCS
<b>B</b> 	15*9.5	34 PCS
<b>C</b> 	6*30	37 PCS
<b>D</b> 	6*20	14 PCS
<b>E</b> 		8 PCS
<b>F</b> 	4*22	4 PCS
<b>G</b> 		2 PCS
<b>H</b> 		4 PCS

<b><u>HARDWARE REQUIRED:</u></b>		
<b>I</b> 		4 PCS
<b>J</b> 		2 PCS
<b>K</b> 	4*12	4 PCS
<b>L</b> 	4*35	4 PCS
<b>M</b> 	5*20	8 PCS
<b>N</b> 		1 PC
<b>O</b> 		1 PC
<b>P</b> 		1 PC

**Attention:**

\*\*\*Mattresses not included.

\*\*\*Some number parts listed on the instruction sheet may not be in parts bag as they may already be assemble. Carefully check parts and packing materials prior to ordering replacements.

\*\*\*Two people are recommended for ease in the assembly of this product.

\*\*\*A Phillips head screwdriver is required for the assembly of this product (not included).

\*\*\*Power tools should not be used to assemble this product.

\*\*\*Estimated time for assembly:120 mins.

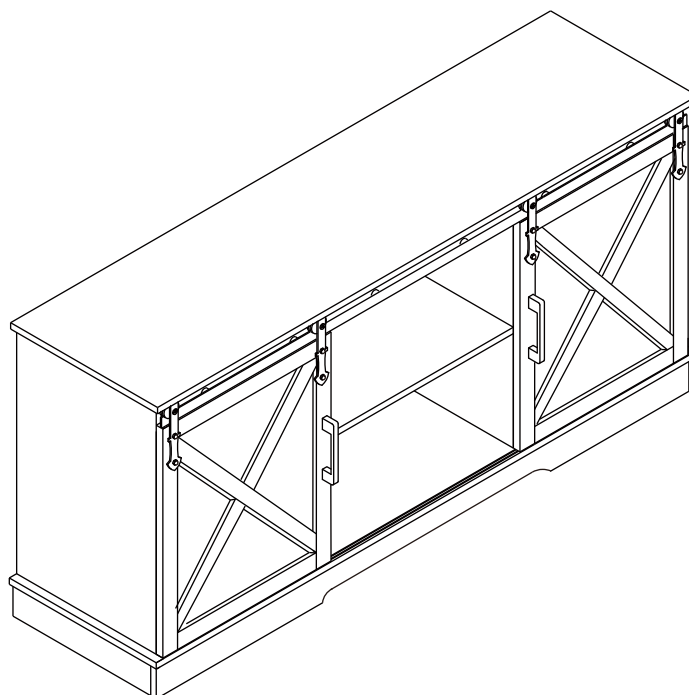

### STEP 1.

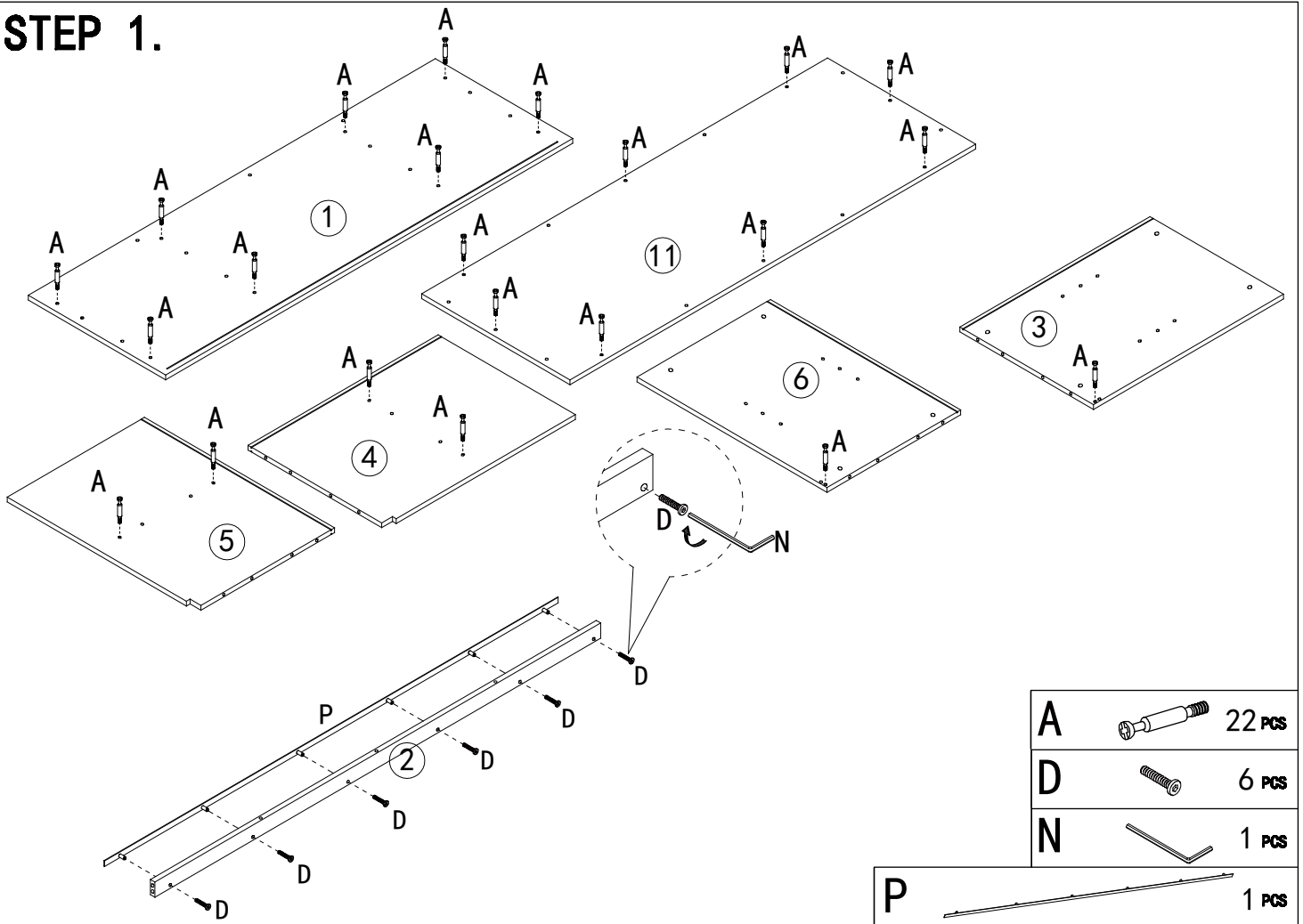

<b>A</b>		22 PCS
<b>D</b>		6 PCS
<b>N</b>		1 PCS

<b>P</b>		1 PCS
----------	--	-------

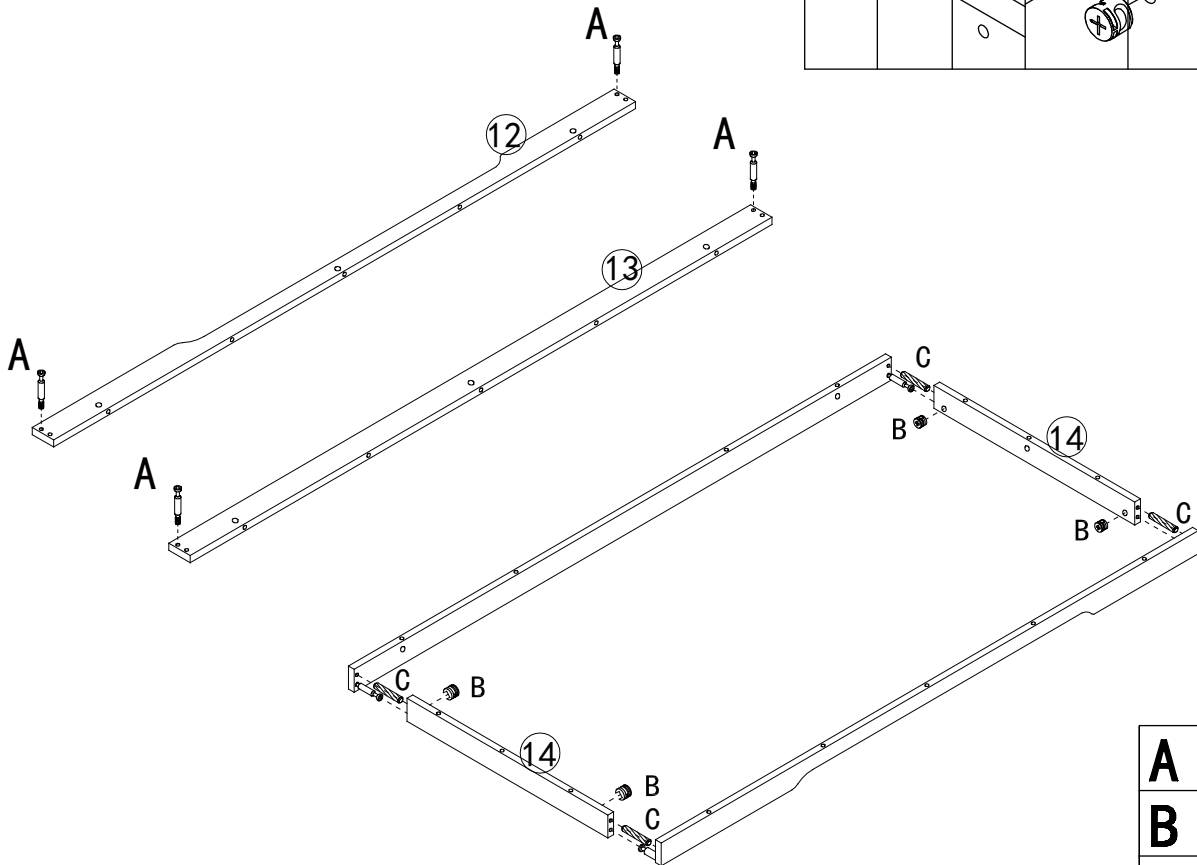
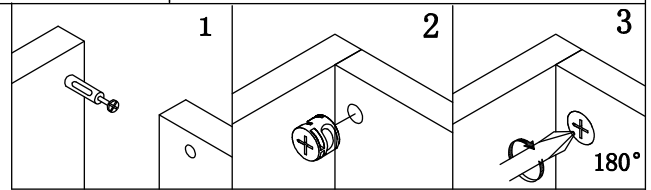

### STEP 2.



<b>A</b>		4 PCS
<b>B</b>		4 PCS
<b>C</b>		4 PCS

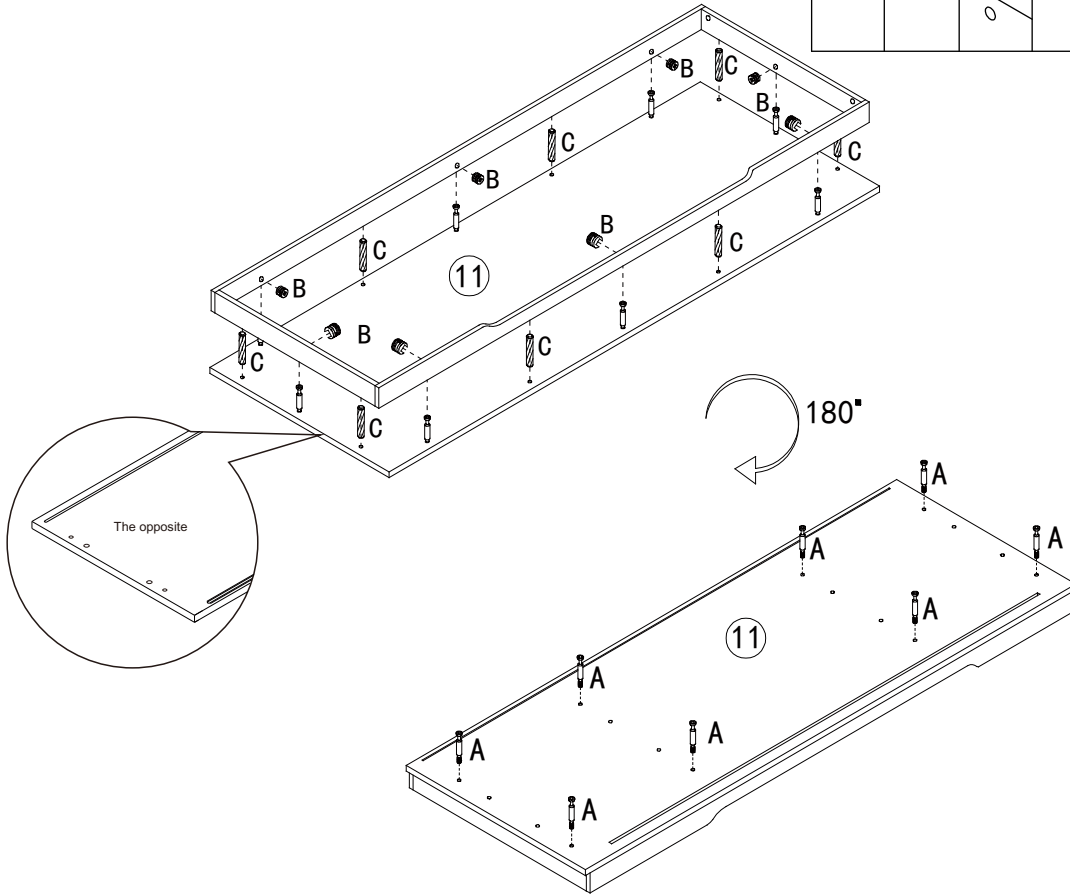
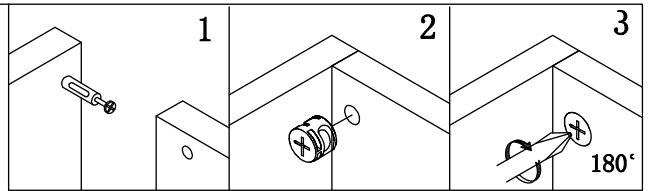

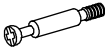
### STEP 3.

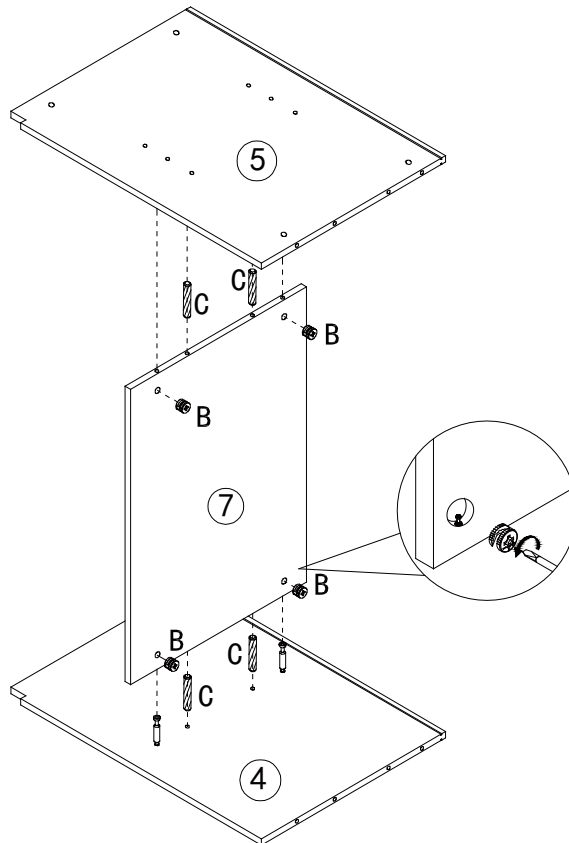

<b>A</b>		8 PCS
<b>B</b>		8 PCS
<b>C</b>		8 PCS

### STEP 4.



<b>B</b>		4 PCS
<b>C</b>		4 PCS

# STEP 5.

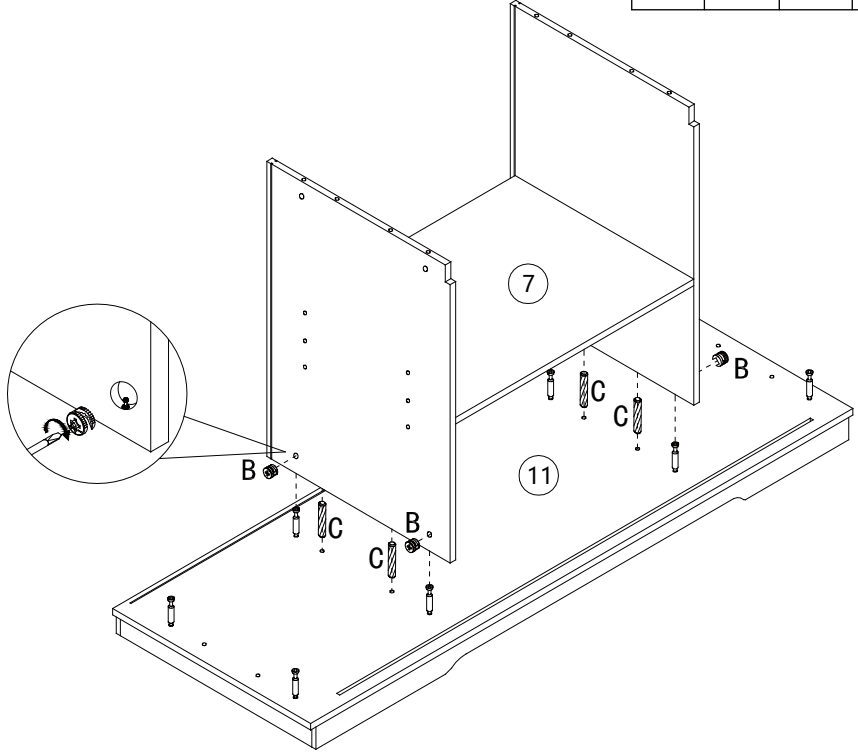
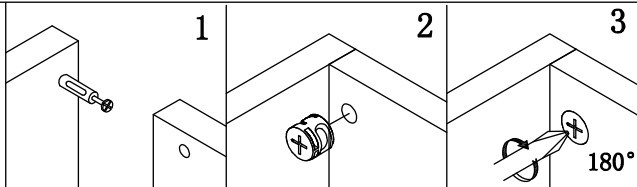

<b>B</b>		4 PCS
<b>C</b>		4 PCS

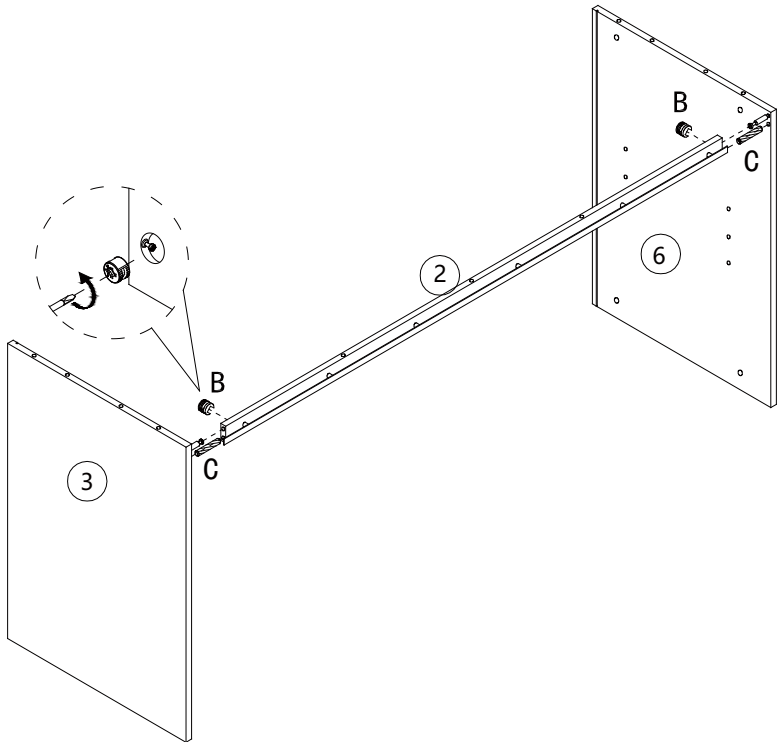

# STEP 6.

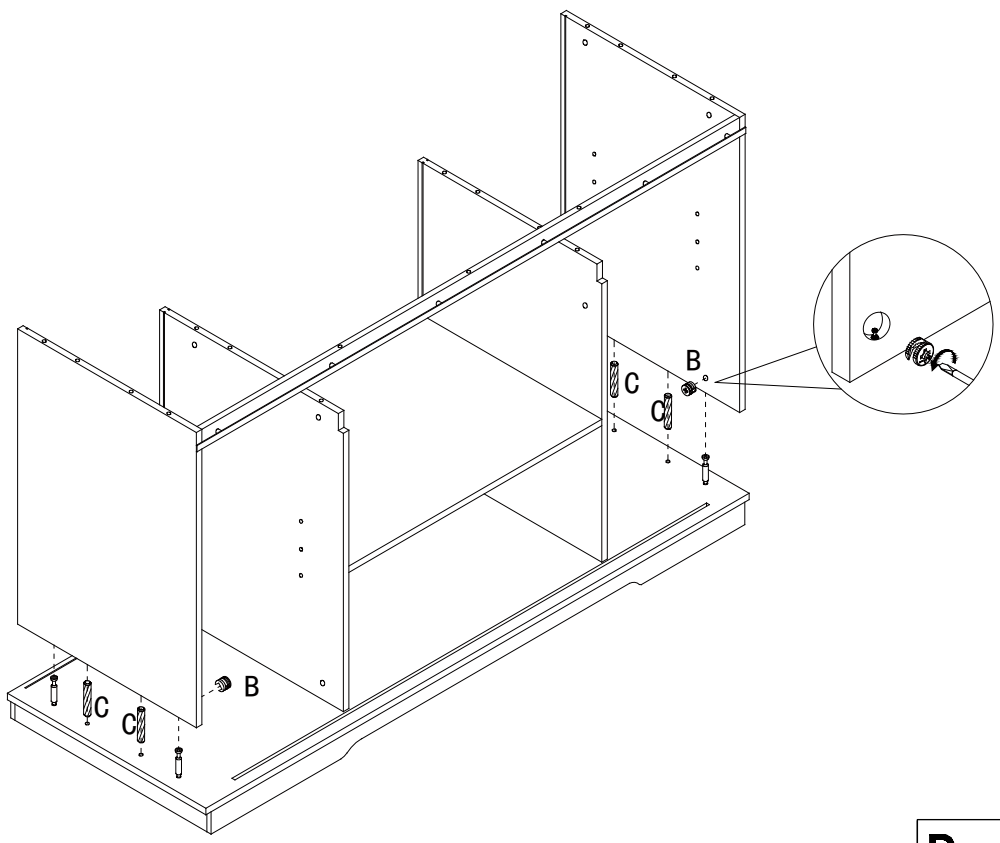

<b>B</b>		2 PCS
<b>C</b>		2 PCS

# STEP 7.



<b>B</b>		4 PCS
<b>C</b>		4 PCS



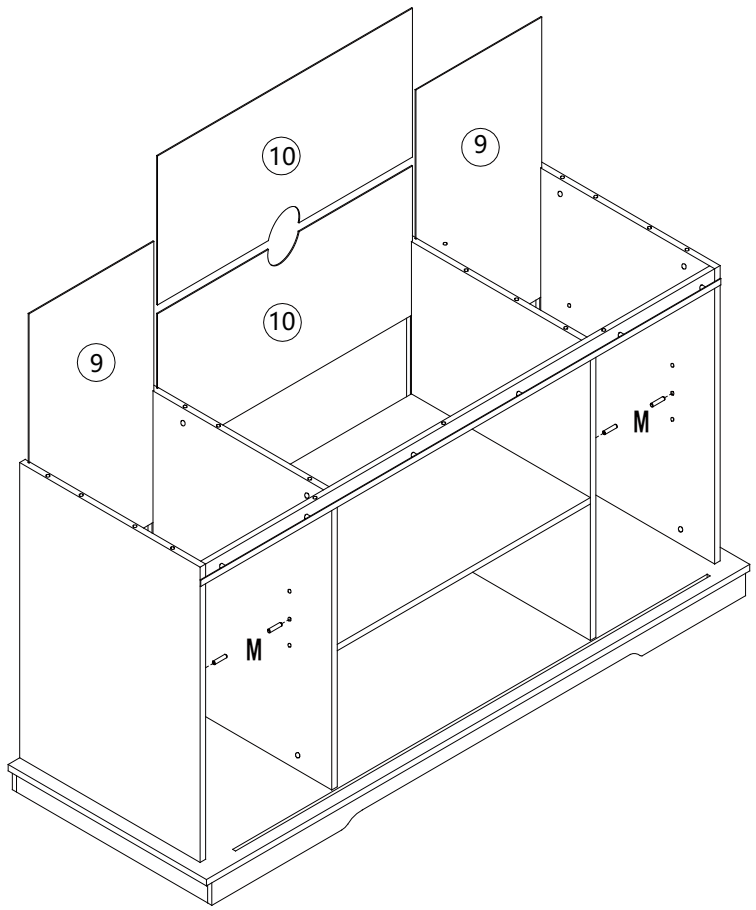



# STEP 8.

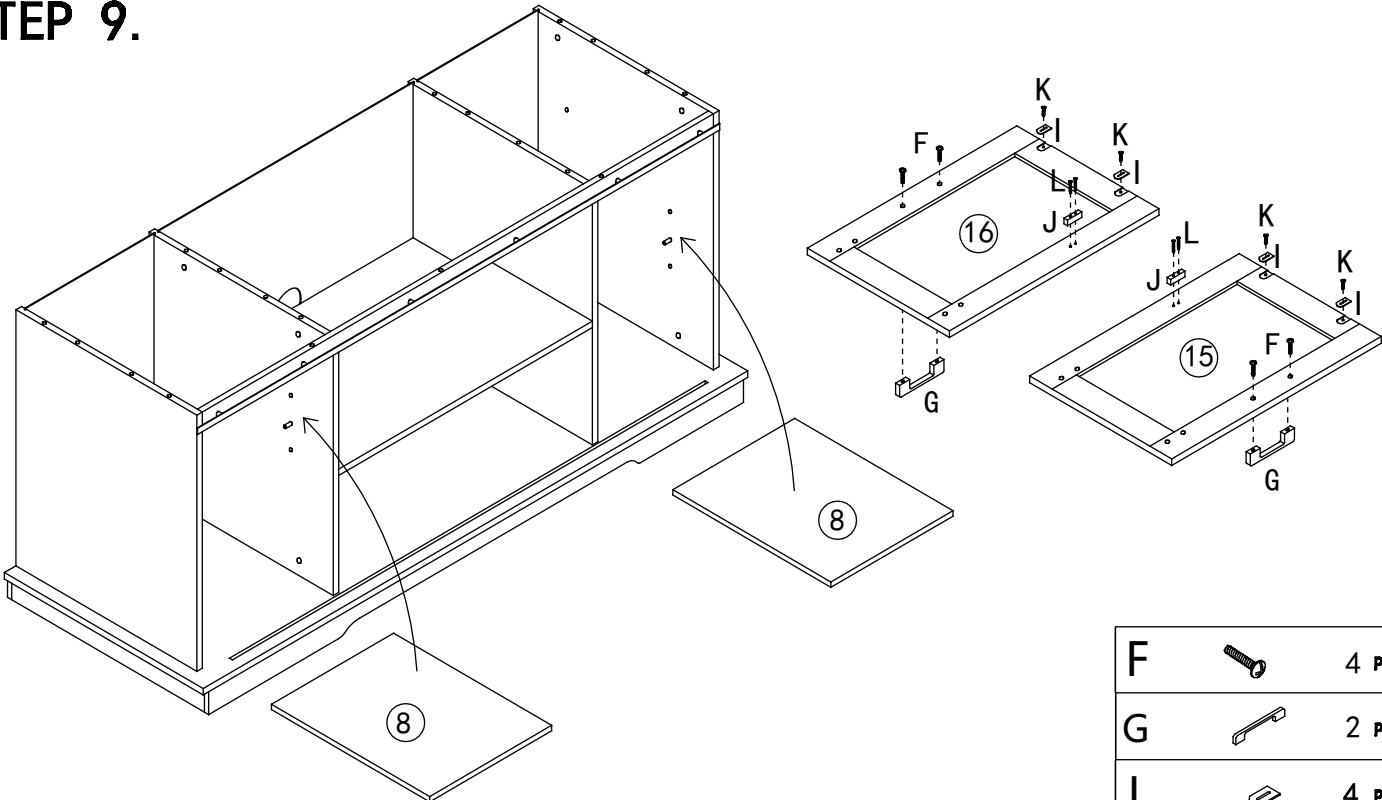

<b>M</b>		8 PCS
----------	---	-------

### STEP 9.



F		4 PCS
G		2 PCS
I		4 PCS
J		2 PCS
K		4 PCS
L		4 PCS



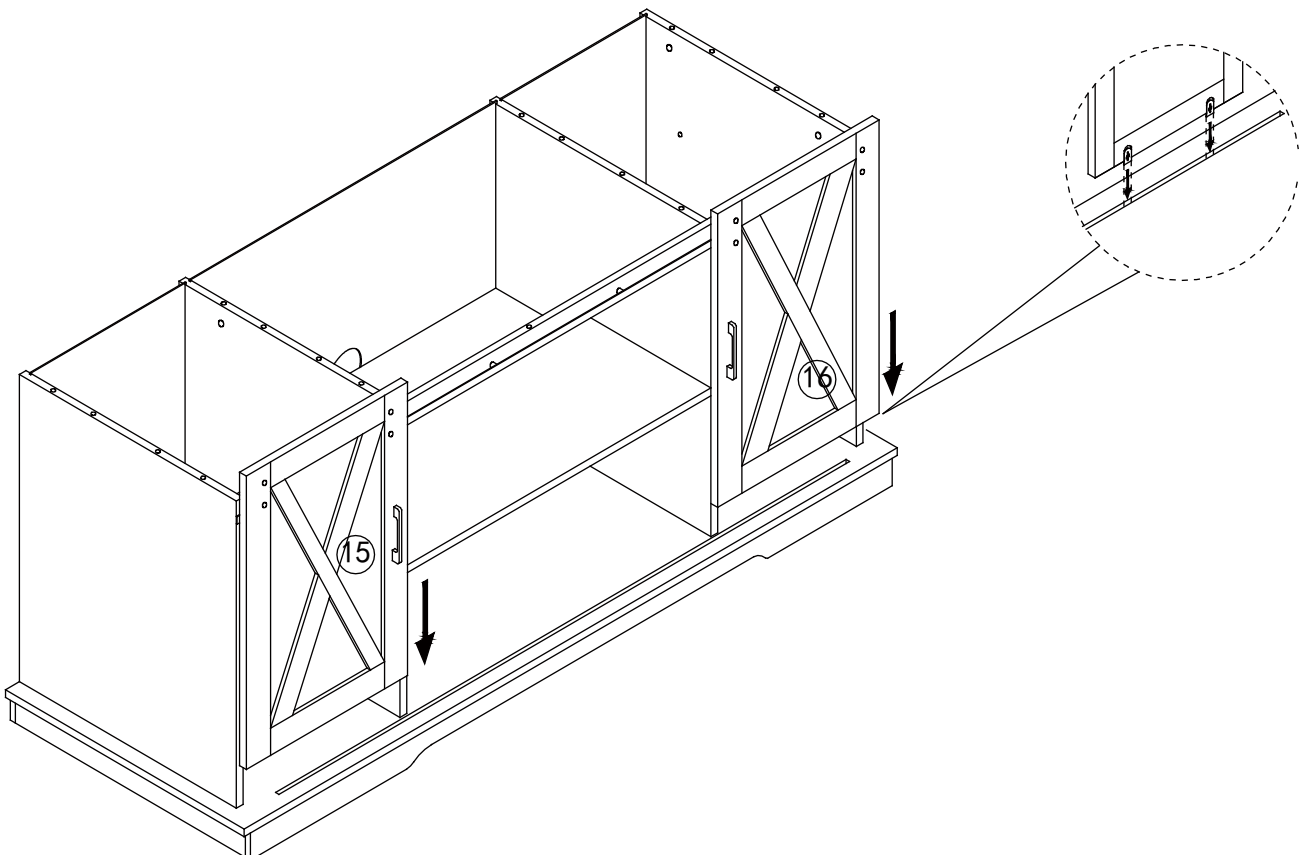

### STEP 10.



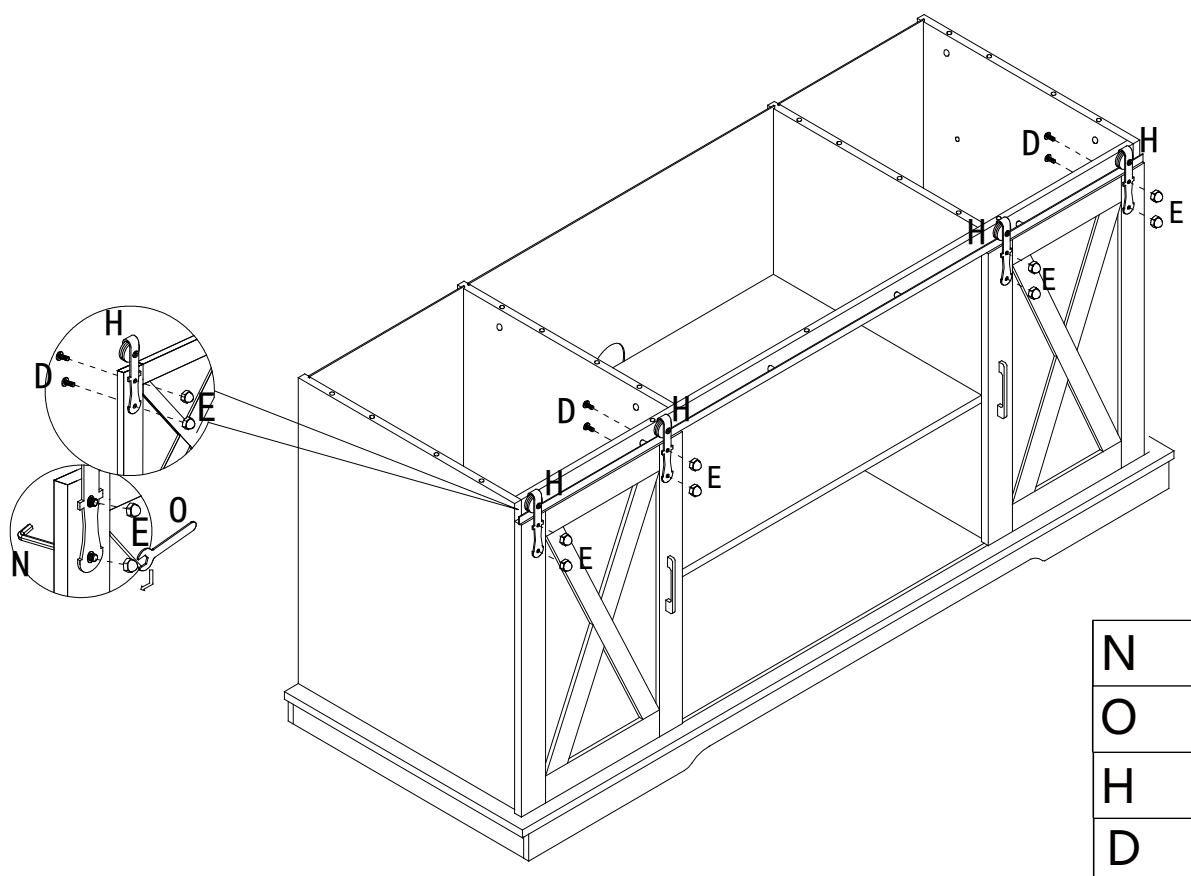



# STEP 11.

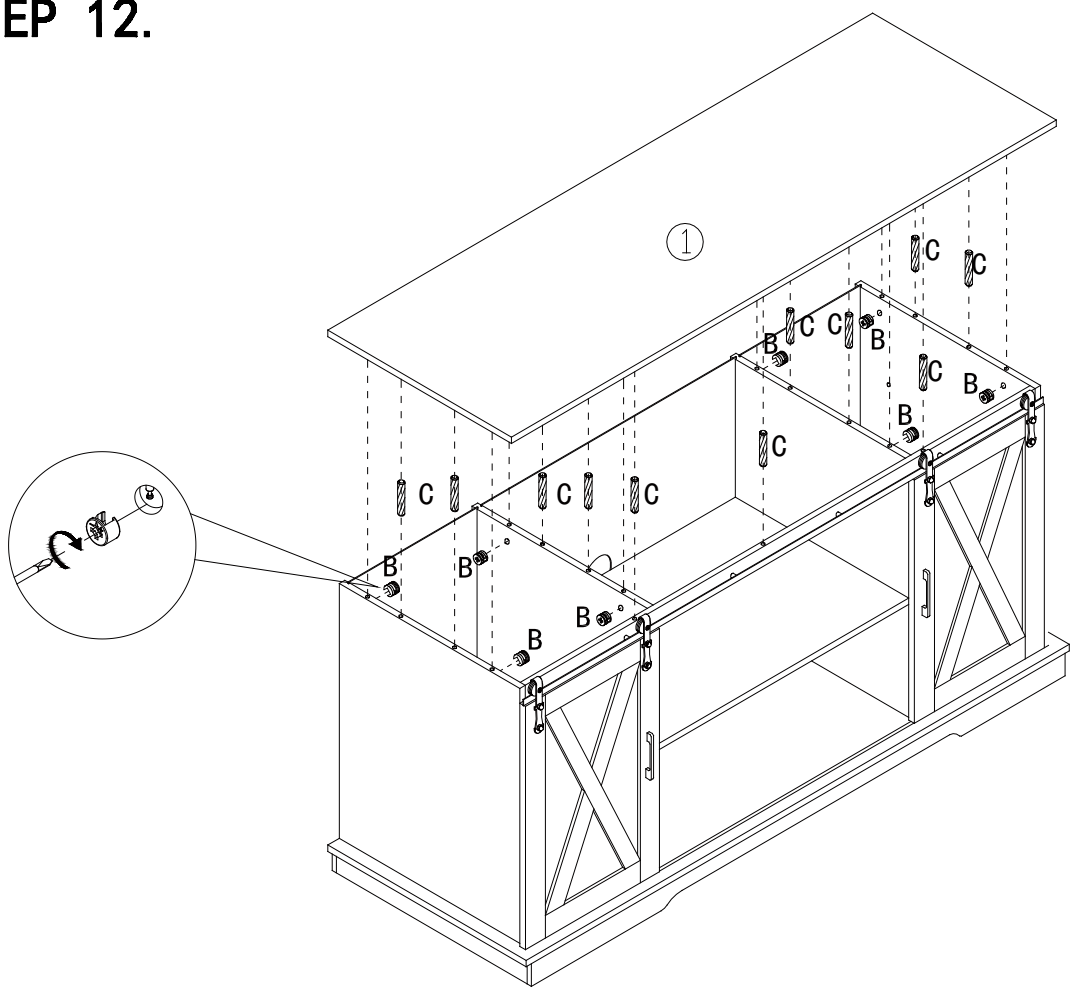

N		1 PCS
O		1 PCS
H		4 PCS
D		8 PCS
E		8 PCS

# STEP 12.



B		8 PCS
C		11 PCS

**STEP 13.**

**STEP 14.**

**STEP 15.**

**STEP 16.**



