







# ASSEMBLY INSTRUCTIONS FOR ACME FURNITURE

## AC17A8334S 2 DOOR MIRRORED CONSOLE

Thank you for purchasing this quality product. Be sure to check all packing material carefully for small parts which may have come loose inside the carton during shipment. Identify and count all parts and metal hardware. Compare with the parts list to be sure all parts are present. If any part(s) are missing or damaged, please contact your local furniture dealer. For efficient and speedy service, please indicate the model number and code letter of part(s) needed.

**\*\* Assemble the product on a flat, soft surface such as a carpet or cloth to prevent scratching the product finish. Read all instruction and study the drawing carefully before starting the assembly process.**

**\*\*\* Do not fully tighten screws until fully assembled \*\*\***

Parts List			Hardware List			
NO	Part	Quantity	NO	Hardware	Size	Quantity
A		1 PC	1		5/16" * 2"	8 PCS
R		2 PCS	2		5/16"	8 PCS
L		2 PCS	3		5/16" * 19mm	8 PCS
			4		5/16"	1 PC

**STEP 1**

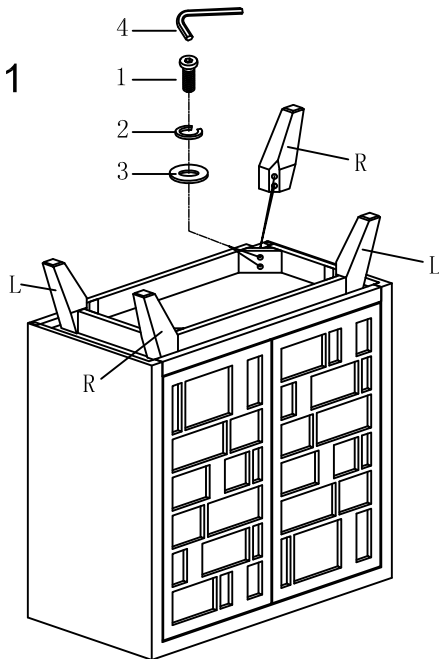

**STEP 2**

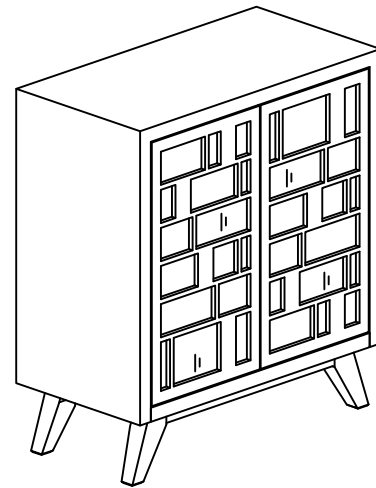

**Attention:**

**\*\*\* Mattresses not included.**

**\*\*\* Some number parts listed on the instruction sheet may not be in parts bag as they may already be assembled. Carefully check parts and packing materials prior to ordering replacements.**

**MADE IN CHINA**