

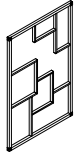

ASSEMBLY INSTRUCTION FOR ACME FURNITURE

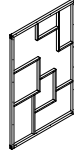



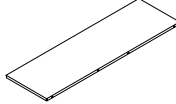
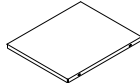
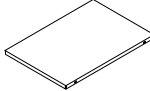
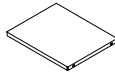
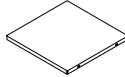

MODEL# 77888 & 77908 SHELF

Thank you for purchasing this quality product. Be sure to check all packing materials carefully for small parts which may have come loose inside the carton during shipment. Separate, identify, and count all parts and metal hardware. Compare with parts list to be sure all parts are present. If any part(s) are missing or damaged, please contact your local furniture dealer. For efficient and speedy service, please indicate the model number and code letter of the part(s) needed.

***** Do not fully tighten screws until fully assembled *****

COMPONENT PARTS		
DECERPTION	PART NAME	Q'TY(PCS)
1	Front Frame 	1pc
2	Back Frame 	1pc
3	Left Frame 	1pc
4	Right Frame 	1pc
5	Top/Bottom Panel 	2pcs
6	Middle Upper/Lower Panel 	2pcs
7	Left Panel 	2pcs
8	Right Upper Panel 	1pc
9	Middle Panel 	1pc

10	Right lower Panel		1pc
----	-------------------	--	-----

<u>HARDWARE REQUIRED:</u>		
A		Bolt 3/16"x3/8" - 44pcs
B		Bolt 1/4"x1-1/8" - 24pcs
C		Allen Wrench M4 - 1pc
D		Screw M4 - 1pc
E		Metal Plate - 2pcs
F		Anchor - 1pc
G		Girding - 1pc

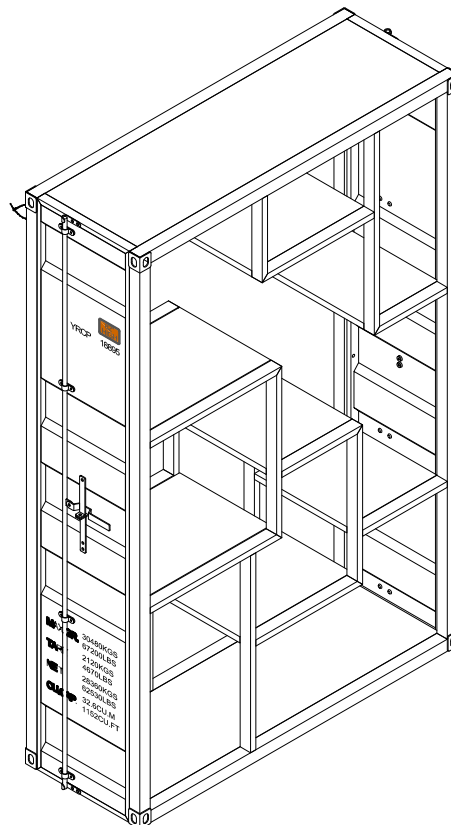

Attention:

***Mattresses not included.

***Some number parts listed on the instruction sheet may not be in parts bag as they may already be assemble. Carefully check parts and packing materials prior to ordering replacements.

How to Assemble:

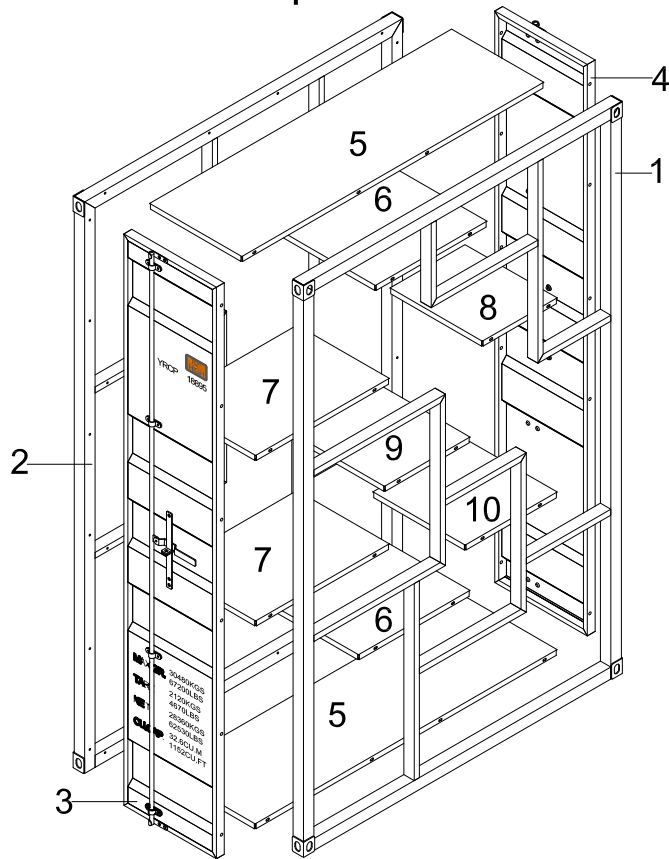

STEP 1.

Exploded View

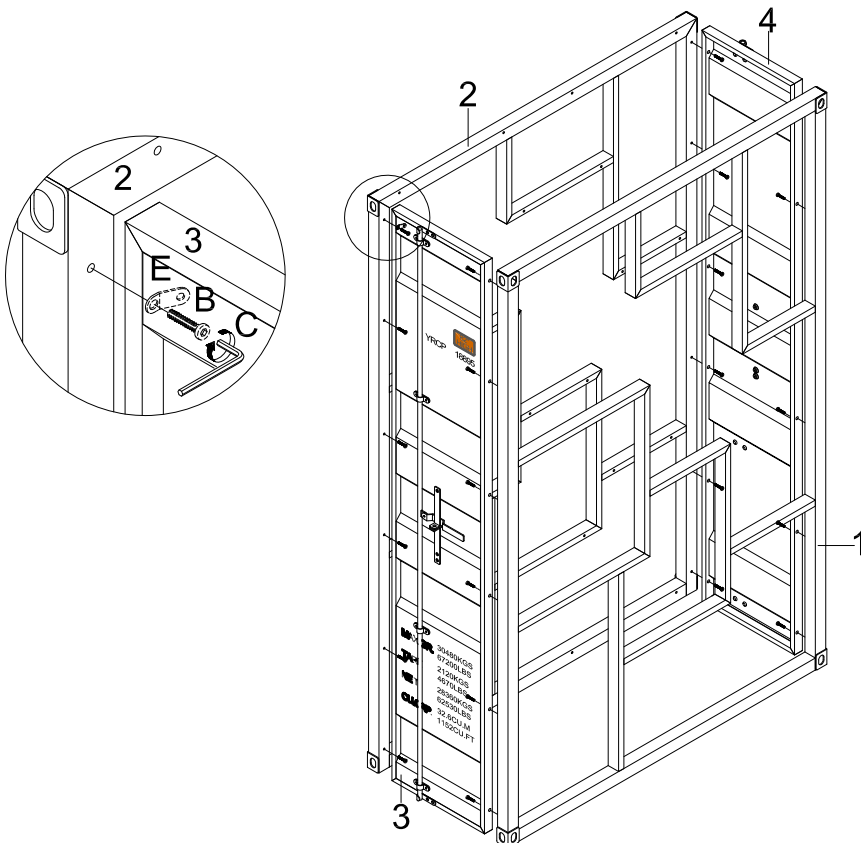

STEP 2.



B		24pcs
E		1pc

How to Assemble:

STEP 3.

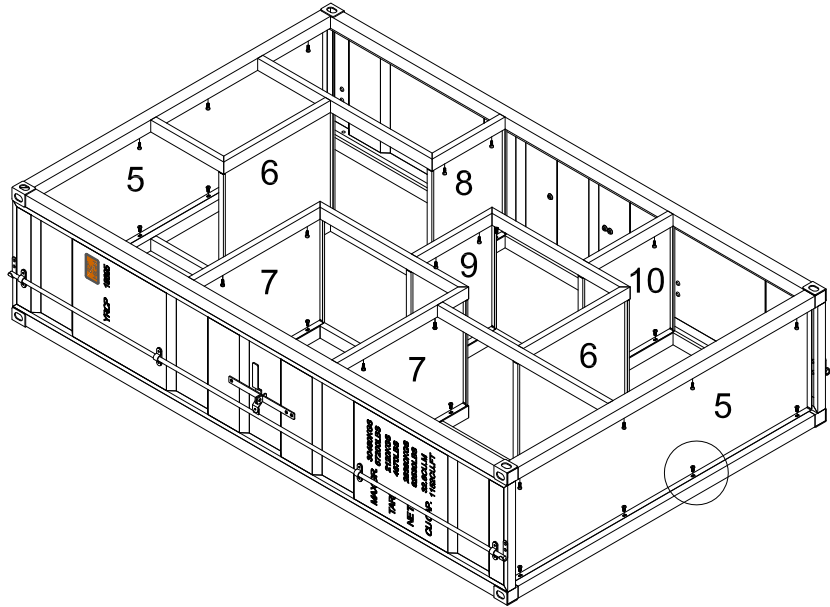
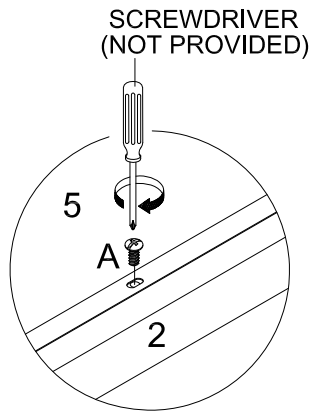

A  44pcs

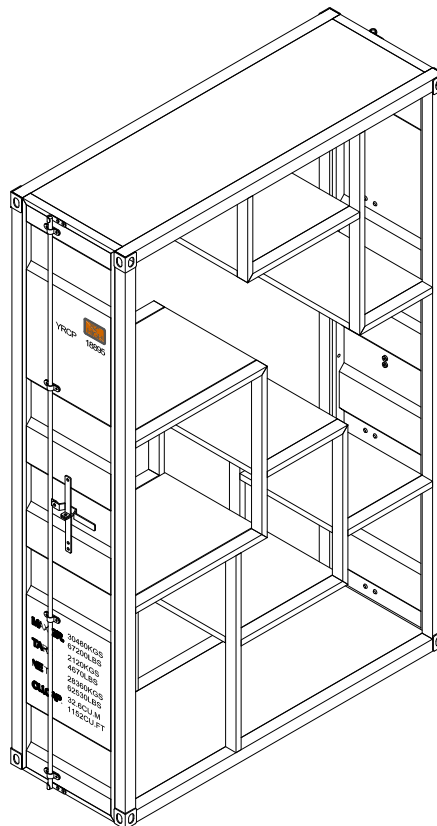

STEP 4.

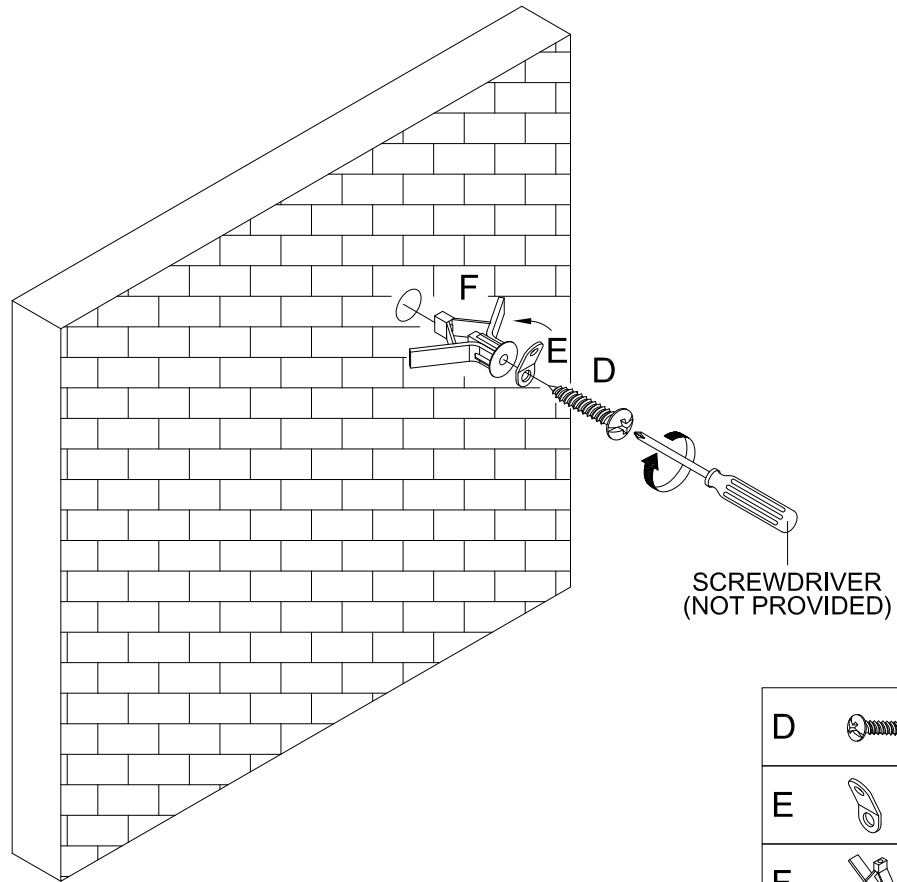

How to Assemble:

STEP 5.



D		1pc
E		1pc
F		1pc

STEP 6.

To Prevent Tip over
Product Must Be
Attached To Wall

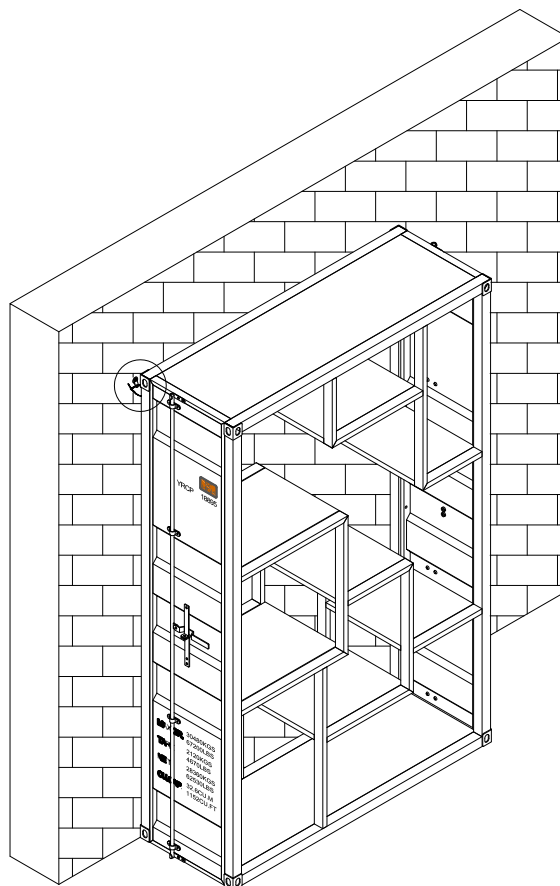
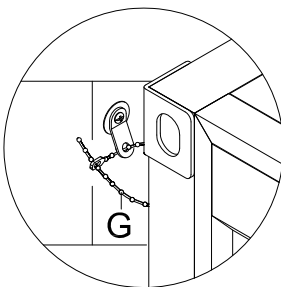

G		1pc
---	---	-----