

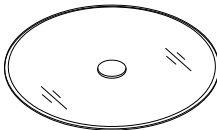



ASSEMBLY INSTRUCTION FOR ACME FURNITURE





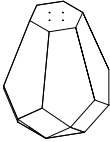



MODEL# 74925 Dining Table

Thank you for purchasing this quality product. Be sure to check all packing materials carefully for small parts which may have come loose inside the carton during shipment. Separate, identify, and count all parts and metal hardware. Compare with parts list to be sure all parts are present. If any part(s) are missing or damaged, please contact your local furniture dealer. For efficient and speedy service, please indicate the model number and code letter of the part(s) needed.

***** Do not fully tighten screws until fully assembled *****

COMPONENT PARTS		
DECERPTION	PART NAME	Q'TY(PCS)
1	Glass Top 	1pc
2	Support 	1pc
3	Base 	1pc
4	Bottom 	1pc

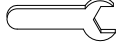
HARDWARE REQUIRED:

A		Bolt 1/4"x5/8" - 4pcs
B		Bolt 1/4"x1-3/4" - 4pcs
C		Bolt 5/16"x3/8" - 4pcs
D		Washer - 4pcs
E		Allen Wrench M4 - 1pc
F		Allen Wrench M5 - 1pc
G		Open End Wrench - 1pc
H		Adjustable Foot - 6pcs

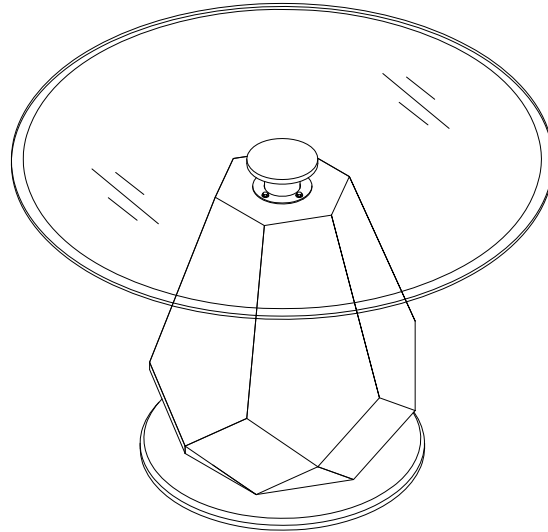

Attention:

***Mattresses not included.

***Some number parts listed on the instruction sheet may not be in parts bag as they may already be assemble.
Carefully check parts and packing materials prior to ordering replacements.

How to Assemble:

STEP 1.

Exploded View

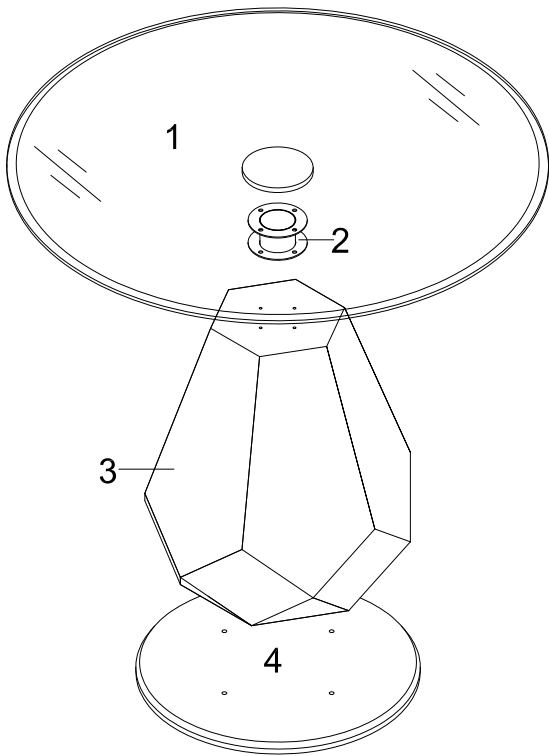

STEP 2.

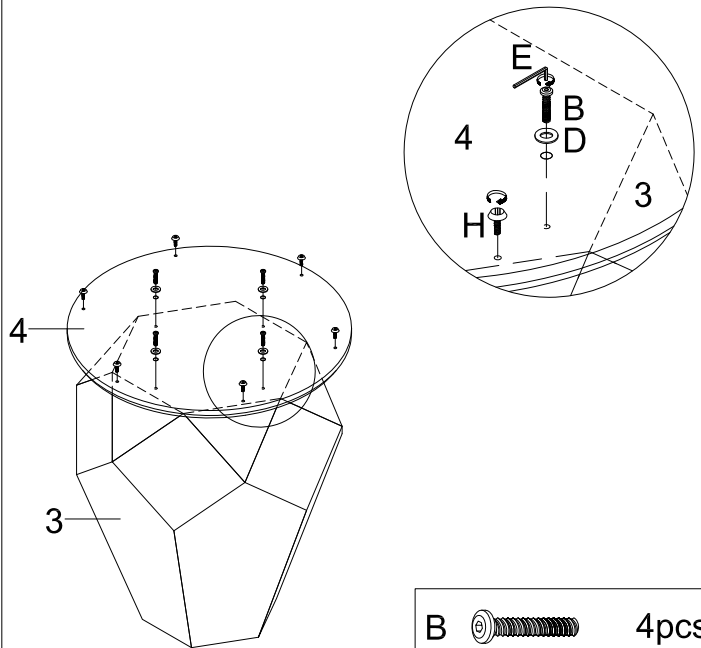

B		4pcs
D		4pcs
H		6pcs

STEP 3.

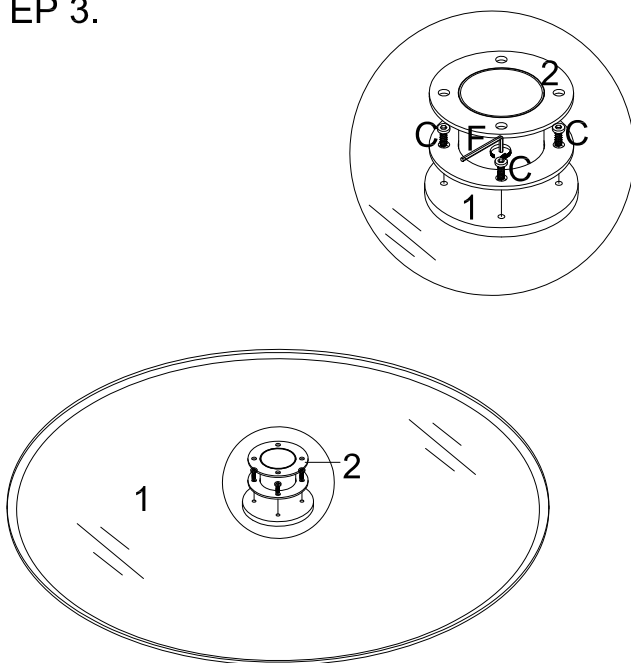

C		4pcs
---	--	------

STEP 4.

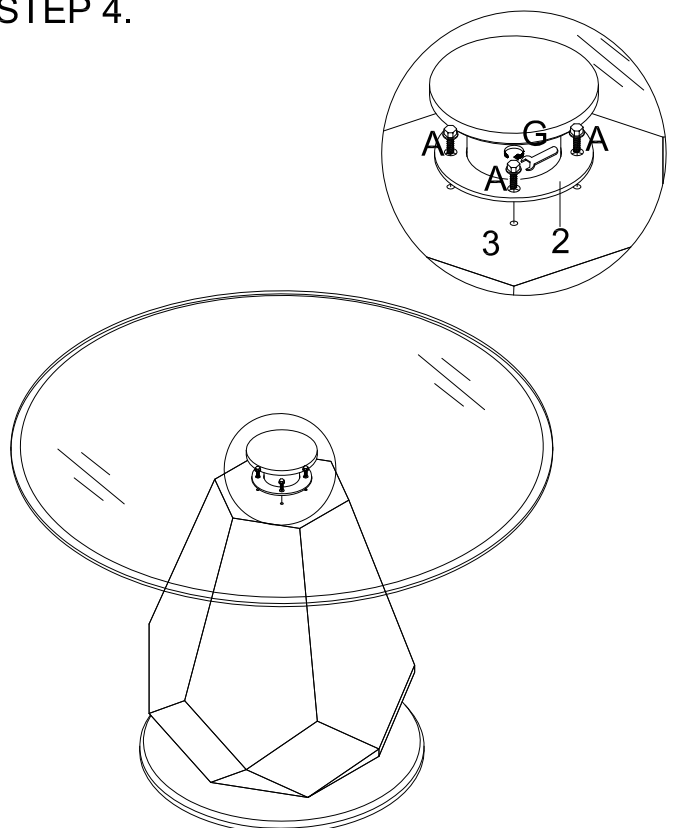

A		4pcs
---	--	------