





ASSEMBLY INSTRUCTION FOR ACME FURNITURE









MODEL#72863

Thank you for purchasing this quality product. Be sure to check all packing material carefully for small parts which may have come loose inside the carton during shipment. Identify and count all parts and metal hardware. Compare with the parts list to be sure all parts are present. If any part(s) are missing or damaged, please contact your local furniture dealer. For the efficient and speedy service, please indicate the model number and code letter of part(s) needed.

Do not fully tighten screws until fully assembled

COMPONENT PARTS		
DESCRIPTION	PART NAME	Q'TY (PCS)
①	CHAIR BACK 	1
②	SEATBOX 	1
③	FRONT LEG 	2
④	ARM 	2

HARDWARES REQUIRED

- (A)  Bolt $\phi 1/4"$ x 75mm - 4 PCS
- (B)  Bolt $\phi 1/4"$ x 63mm - 4 PCS
- (C)  Bolt $\phi 1/4"$ x 38mm - 6 PCS
- (D)  Spring Washer $\phi 1/4"$ x $\phi 12$ - 14 PCS
- (E)  Flat Washer $\phi 1/4"$ x $\phi 19$ - 14 PCS
- (F)  Wood Screw #8x1-1/2" - 2 PCS
- (G)  Allen Key 4mm - 1 PC
- (H)  Screw Driver (Not provided)

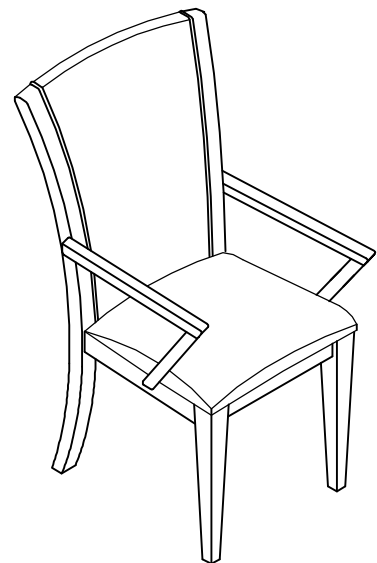

Attention:

***Some number parts listed on the instruction sheet may not be in parts bag as they may already assembled. Carefully check parts and packing materials prior to ordering replacements.

How to assemble:

STEP 1

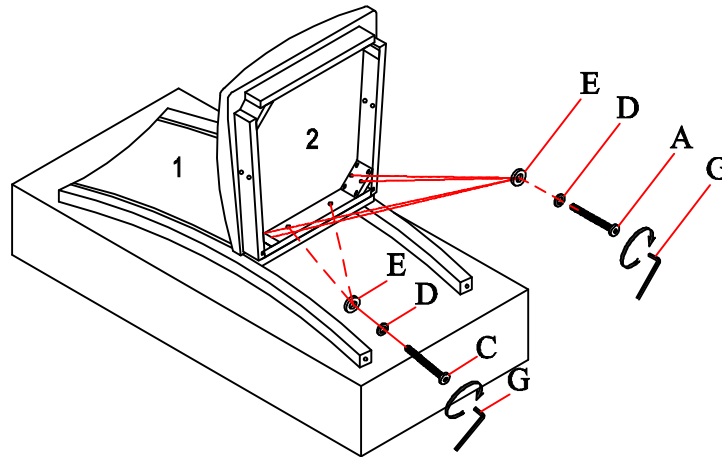

STEP 2

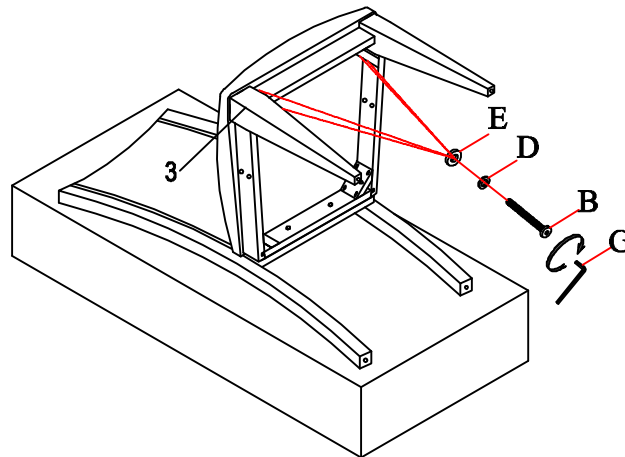

STEP 3

