

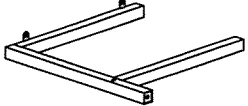

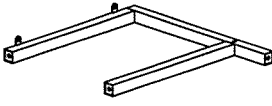



ASSEMBLY INSTRUCTION

BLACK POWDER COAT FINISH COUNTER HEIGHT CHAIR

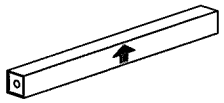
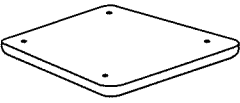
A Chair Back  1 pc	B Left Leg  1 pc	C Right Leg  1 pc	D Front Frame  1 pc
E Front Tube  1 pc	F Seat  1 pc	G Bolt 1/4" x 18mm  6 pcs	H Bolt 1/4" x 47 mm  6 pcs
I Foot Pad  4 pcs	J Allen wrench  1 pc		

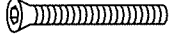
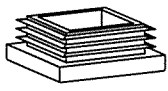

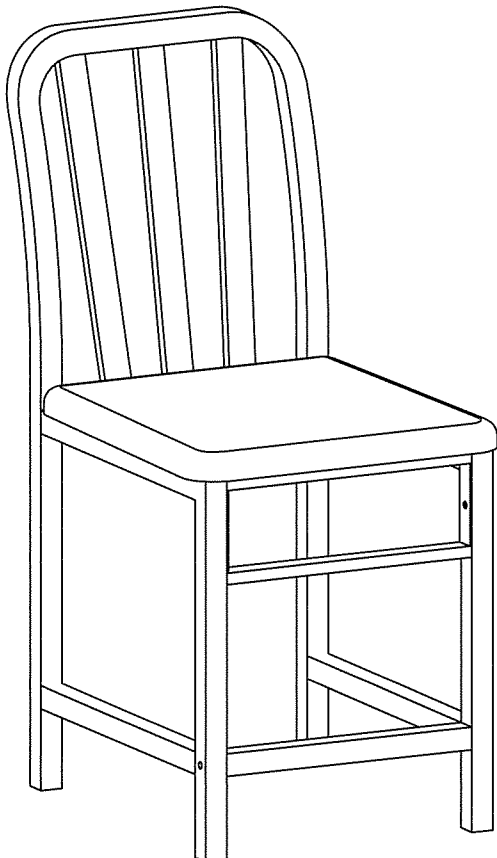
This page lists all the contents included in the box. Please take the time to identify the hardware as well as the individual components to this product. As you unpack and prepare for assembly, place the contents on a carpeted or padded area to protect them from damage.

1

Insert the foot pad (I) into chair back (A), left leg (B) and right leg (C).

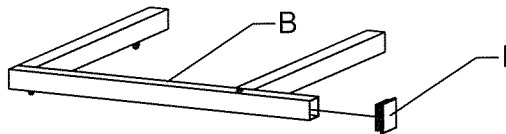
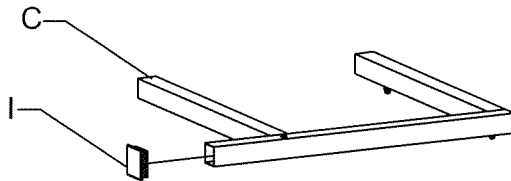
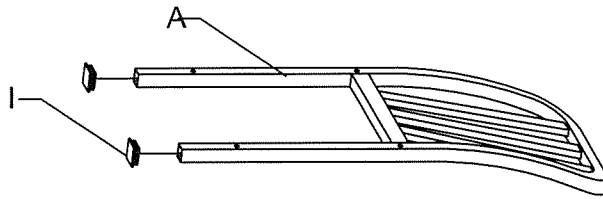

I  X 4 pcs

2

Assemble the chair back (A), left leg (B) and right leg (C) and use the bolt (H) through the chair back (A) into left leg (B) and right leg (C) as shown as drawing and tighten with the wrench (J).

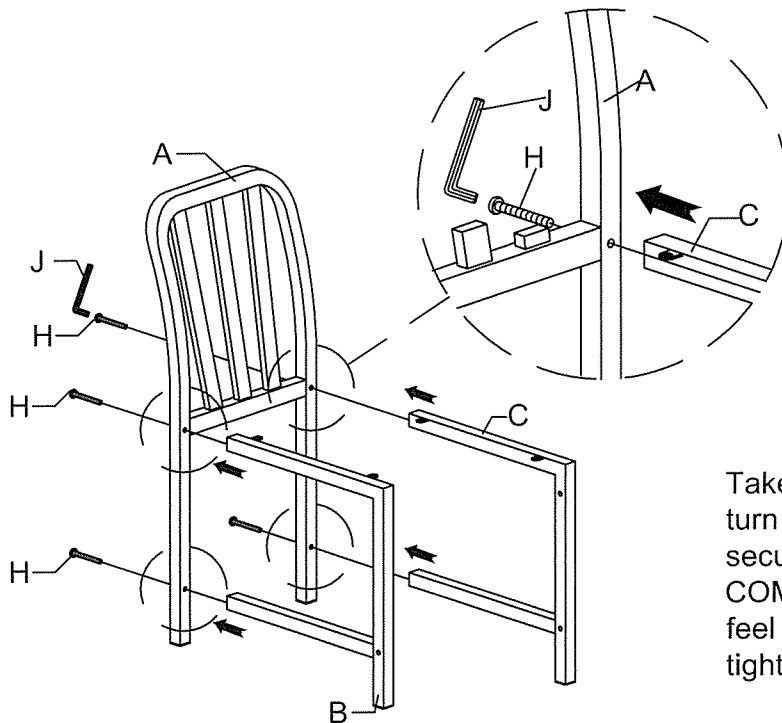

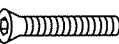



J 
H  X 4 pcs

Take the Allen Wrench, and turn the bolts until the legs are secure. **DO NOT TIGHTEN COMPLETELY.** Stop when you feel you are adding force to tighten the bolt.

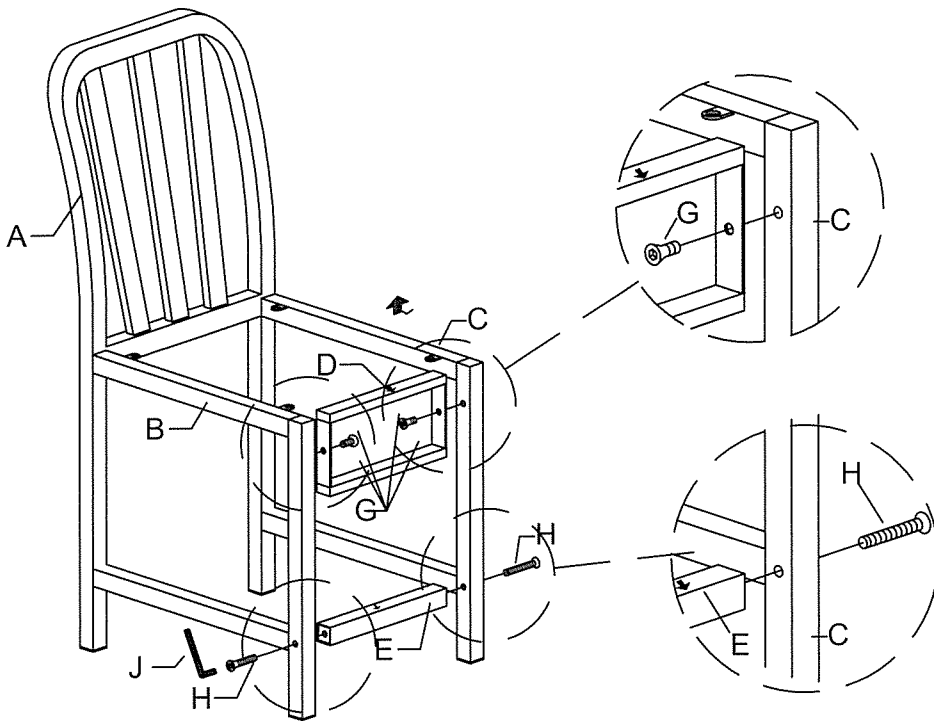
3

Assemble the front frame(D), left leg(B) and right leg(C) with bolt(G). Assemble front tube(E), left leg(B) and right leg(C) with bolt(H) then fastened all bolts using allen wrench (J).





- J 
- G  X 2 pcs
- H  X 2 pcs

4

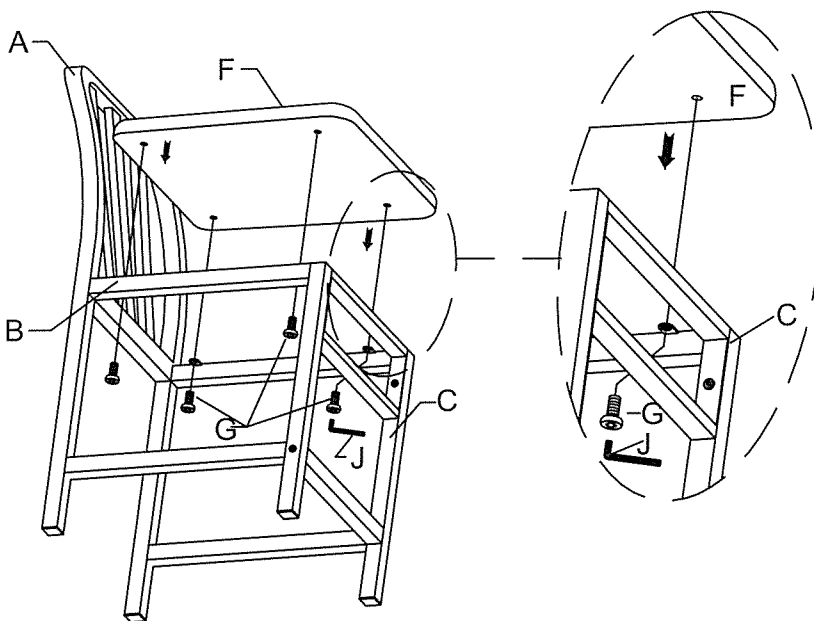
Assemble the seat(F), left leg(B) and right leg(C) with bolt(G) then fastened using allen wrench (J).



- J 
- G  X 4 pcs

Stand chair up on an even surface and check that it is balanced. If there is a slight wobble, apply downward pressure in the corner where a leg is uneven. Keeping pressure in that corner, tighten all bolts. If balanced, apply downward pressure evenly in the center and tighten all bolts. Do not over-tighten beyond hole depth.

Helpful Tip:- Instead of applying downward pressure while reaching under to tighten bolts, have someone sit in the chair while you tighten the bolts.

Cleaning & Care

Treat surface with care. Surface is resistant to scratches but is not scratch resistant. Clean surfaces with a dry or damp soft cloth. Do not use abrasive cleaners. Hardware may loosen over time. Periodically check that all connections are tight.