







Assembly Instructions

PARTS LIST

NO.	DESCRIPTION	SKETCH	QTY
A	BACKREST		1pc
B	FRONT LEG		2pcs
C	CUSHION		1pc
D	Wrench $\phi 5/16"$		1pc
E	Bolt $\phi 5/16 \times 3-1/2"$		4pcs
F	Bolt $\phi 5/16 \times 2-1/4"$		5pcs

STEP 1

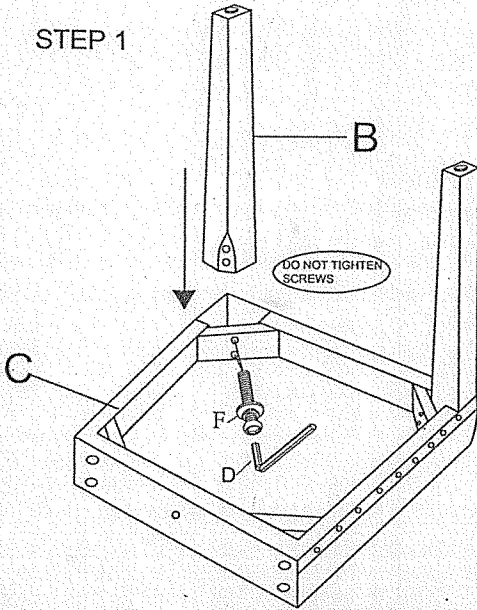

STEP 3

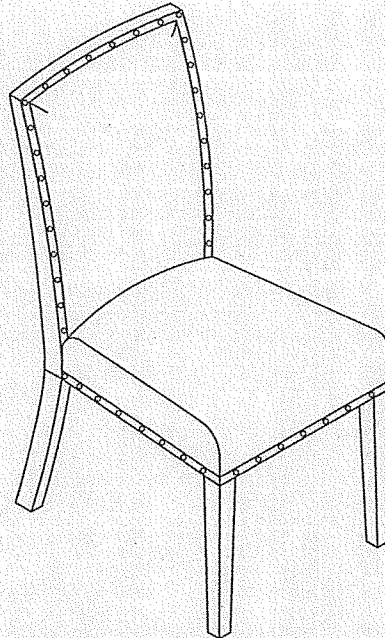

STEP 2

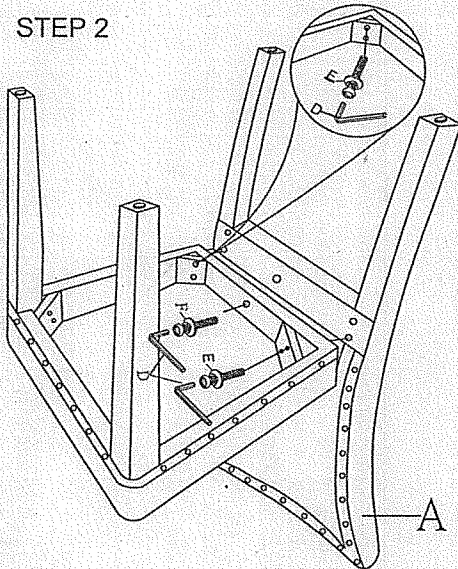

VERY IMPORTANT!

CARING INSTRUCTIONS

NEVER

USE GLASS CLEANERS ON FINISHED FURNITURE, AMMONIA WILL CHEMICALLY ATTACK THE LACQUER

NEVER

ALLOW LIQUIDS OF ANY KIND TO REMAIN IN DECORATIVE ROUTE LINES. ABSORPTION CAUSES WOOD TO WARP AND FINISHES TO DE-LAMINATE

DO NOT WRITE DIRECTLY ON SURFACE

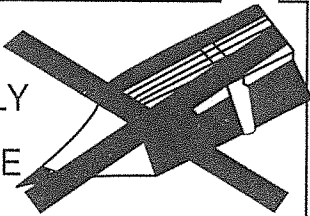

PREVENT MARKING

DO NOT PLACE IN DIRECT SUNLIGHT

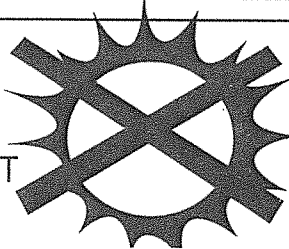

PREVENT FADING

DO NOT USE RUBBER-BASED PLACEMATS USE CLOTHS!

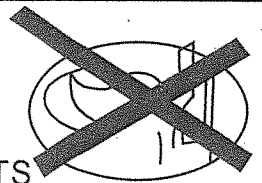

PREVENT DISCOLORING

DO NOT USE COMMERCIAL WAXES AND POLISHES



PREVENT YELLOWING

DO NOT PLACE HOT KETTLES POTS, ETC ON SURFACE

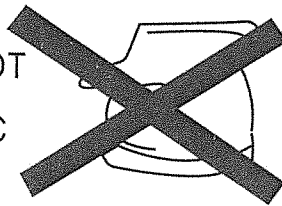

PREVENT DAMAGE TO FINISH!

MAINTAIN EVEN HUMIDITY CONDITIONS IN YOUR HOME

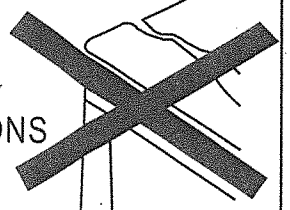

PREVENT SPLITTING

TO CLEAN

SIMPLY USE A SOFT CLOTH MOISTENED IN LEMON OIL POLISH OR LUKEWARM SOAP & WATER THEN BUFF WITH A DRY CLEAN CLOTH!

