







# ASSEMBLY INSTRUCTIONS

## MODEL: #71855T/71856ST

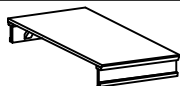
Important note :

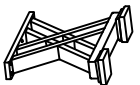
- Place all wooden parts on a clean and smooth surface such as a rug or carpet to avoid scratching the parts.
- Kindly follow the assembly instructions step by step.
- Do not tighten all screws and bolts until the chair is fully assembled.

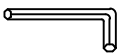
PARTS LIST				HARDWARE LIST			
NO	DESCRIPTION	SRETCH	QTY	NO	DESCRIPTION	SRETCH	QTY
A	TABLE TOP		1 Pc	1	BOLT		12 Pcs
B	TABLE LEAF		1 Pc	2	SPRING WASHER		12 Pcs
C	TABLE LEG		2 Pcs	3	FLAT WASHER		12 Pcs
				4	ALLEN KEY		1 Pc

### STEP 1

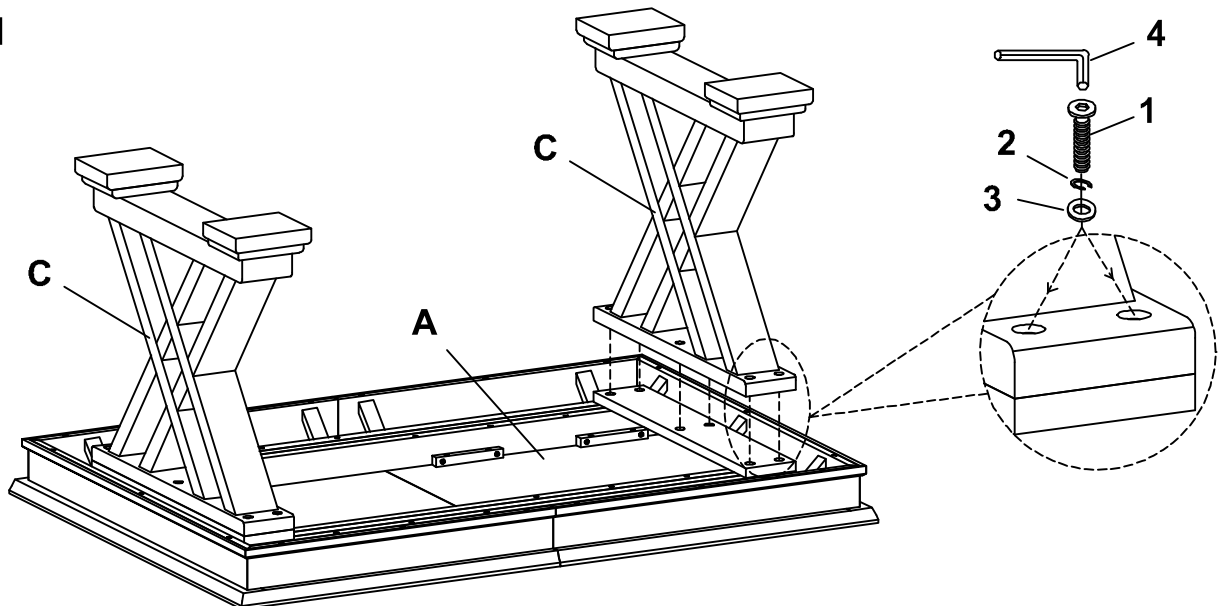

### STEP 2

