









HARDWARE LIST

PART LIST

1	1/4*15	28PCS	2		28PCS	3		28PCS	4	5*20	8PCS	A		2PCS	B		2PCS	C		2PCS	D		2PCS
																							
5		1PC										E		2PCS	F		2PCS						
																							

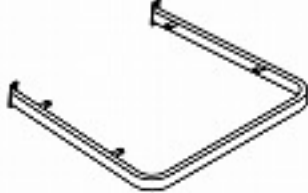
ASSEMBLY INSTRUCTION

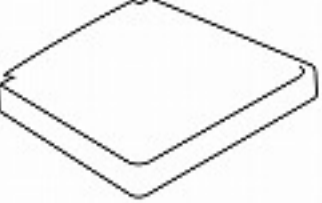
2PCS/CTN

STEP: 1

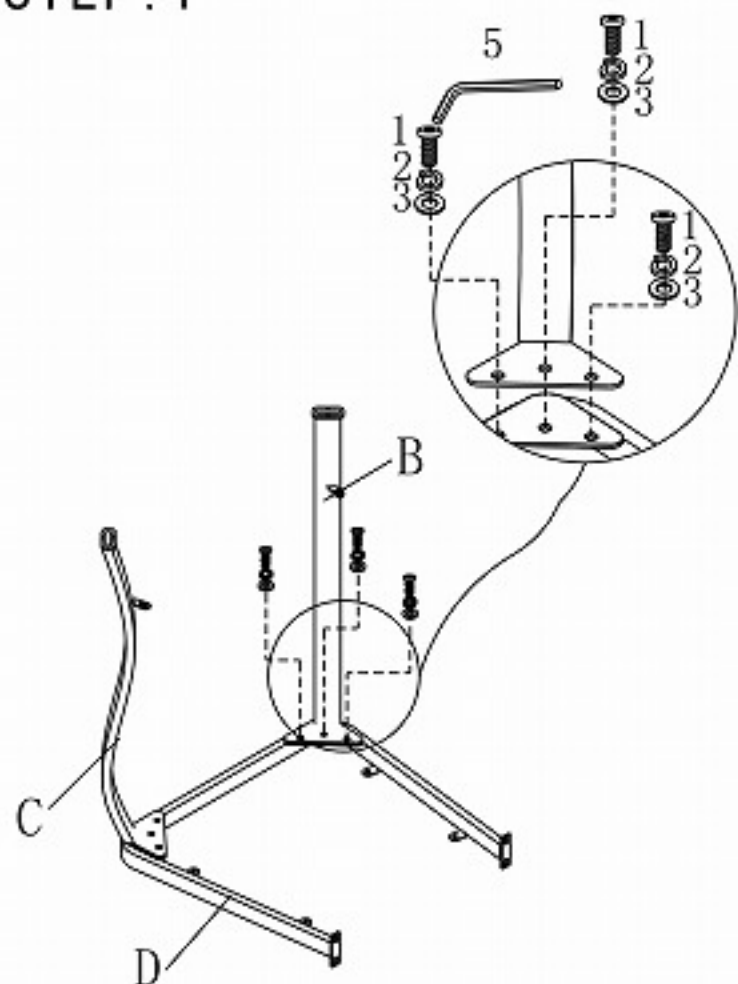

STEP: 2

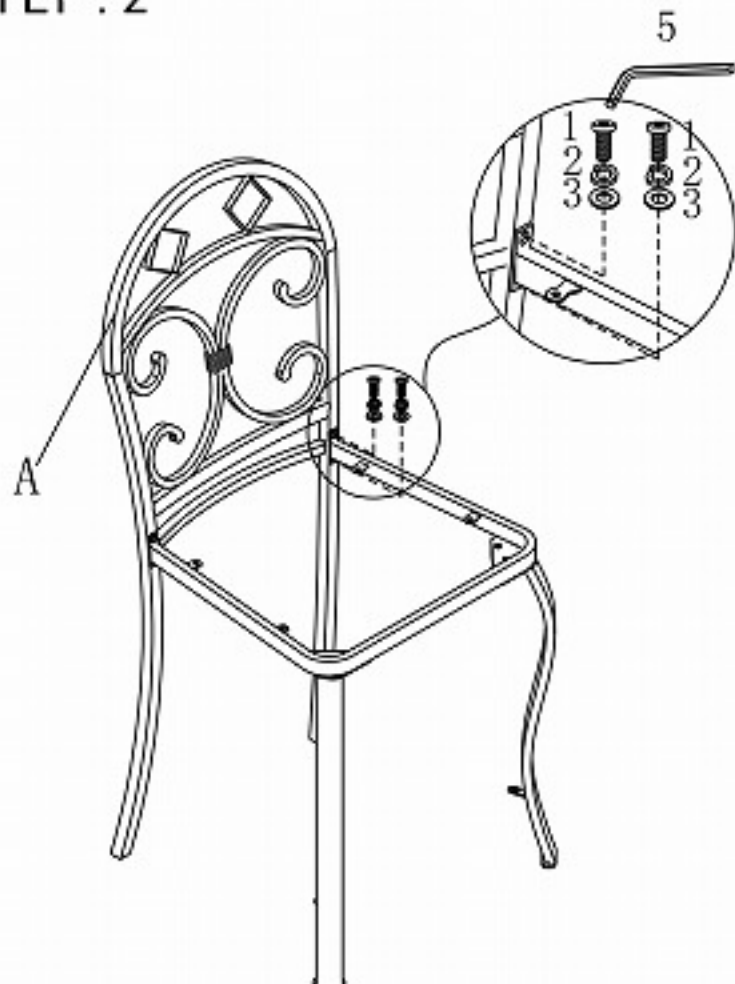

STEP: 3

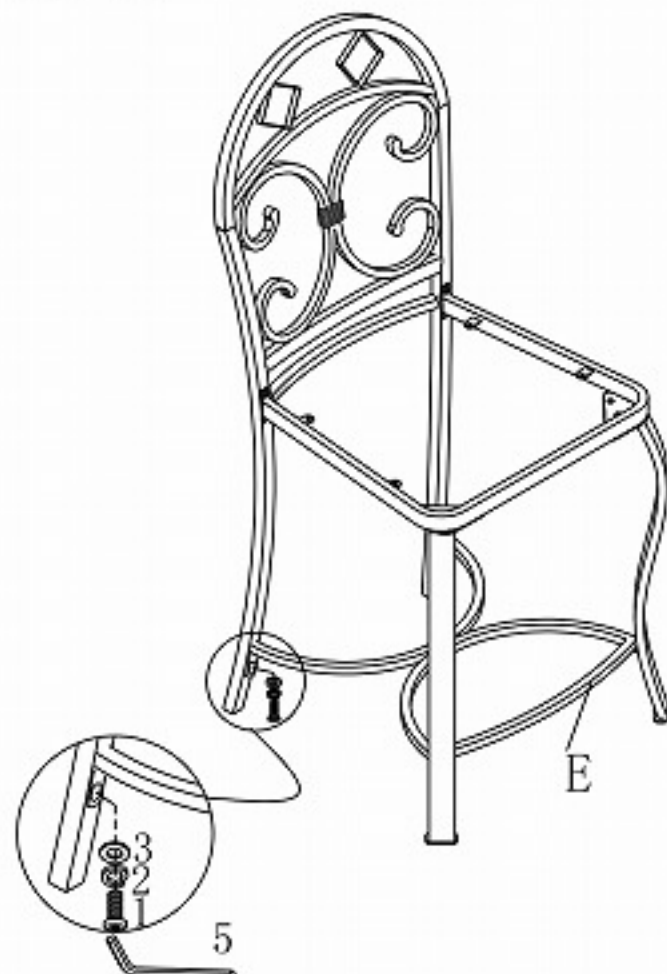

STEP: 4

