

ASSEMBLY INSTRUCTION

Step 1:

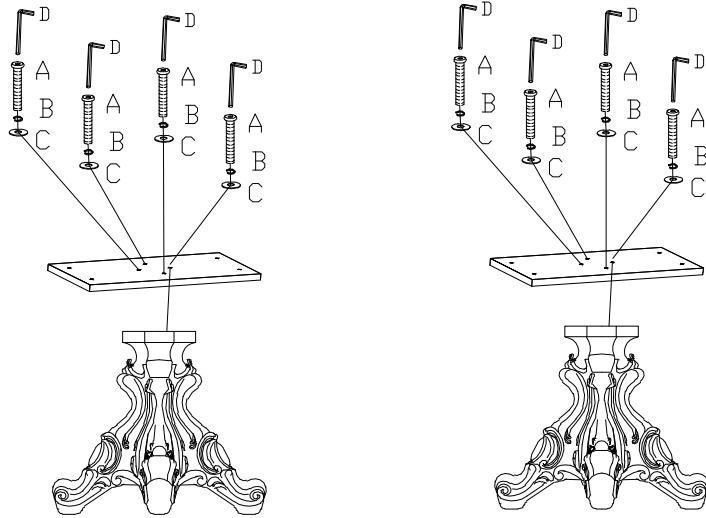

Step 2:

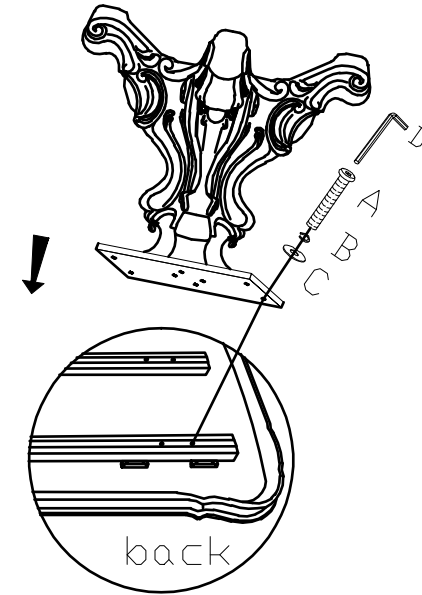



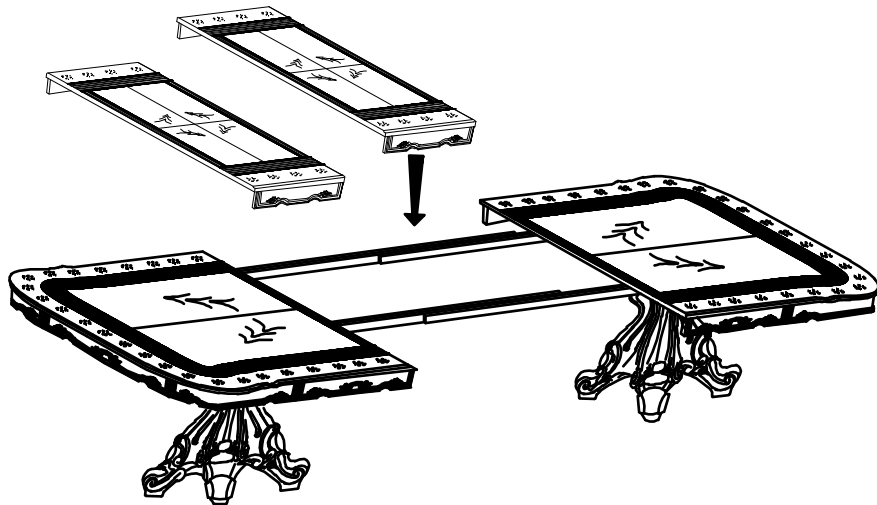

Step 3:

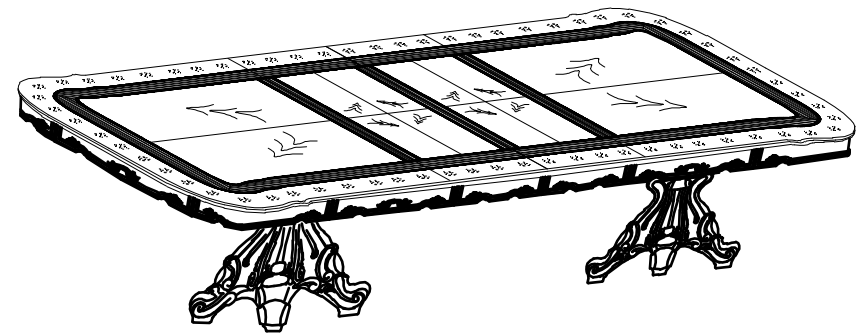

Finish:



No.:	Description	Drawing	Size	Q' ty
A	Short Bolt		Ø5/16"X2"	16
B	Lock Washer		Ø5/16"X12mm	16
C	Flat Washer		Ø5/16"X22mm	16
D	Allen Wrench		5mm	1