

ASSEMBLY INSTRUCTION FOR ACME FURNITURE









MODEL# 66185 DUKE TABLE

Thank you for purchasing the quality product. Be sure to check all packing material carefully for small parts which may have come loose inside the carton during shipment. Separate, identify and count all parts and metal hardware. Compare with all parts list to be sure all parts are present. If any part(s) are missing or damaged, please contact your local furniture dealer. For efficient and speedy service, please indicate the model number and code letter of part(s) needed.

*****Do not fully tighten screws until fully assembled*****

DESCRIPTION	COMPONENT PARTS	
	PART NAME	Q'TY (PCS)
P1	TABLE TOP	1
P2	TABLE LEG	4
P3	SIDE STRETCHER	2
P4	STRETCHER	1

HAREWARES REQUIRED

H1		JCBC BOLT M8 x 60MM - 12 PCS
H2		SPRING WASHER - 12 PCS
H3		FLAT WASHER - 12 PCS
H4		ALLEN KEY M5 - 1 PC
H5		JCBC BOLT M6 x 50MM - 4 PCS
H6		SPRING WASHER - 4 PCS
H7		FLAT WASHER - 4 PCS
H8		ALLEN KEY M4 - 1 PC
H9		ADJUSTER - 4 PCS

Attention:

*** Some number parts listed on the instruction sheet may not be in parts bag as they may already be assembled. Carefully check parts and packing materials prior to ordering replacements.

How to assemble:

STEP 1:

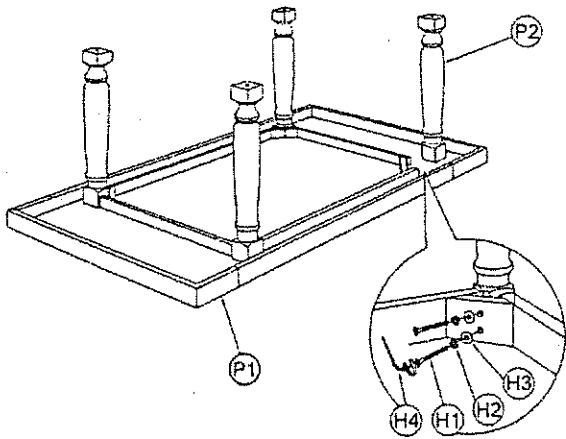

STEP 2:

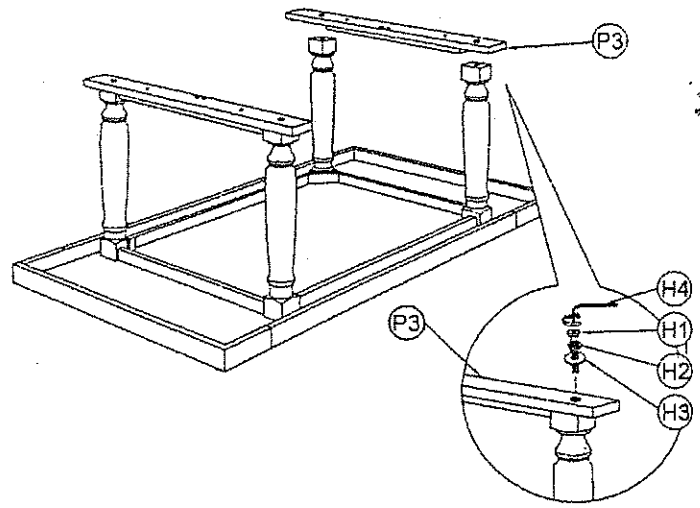

STEP 3:

