

ASSEMBLY INSTRUCTION

*DO NOT TIGHTEN SCREW UNTIL COMPLETELY ASSEMBLY!

Step1

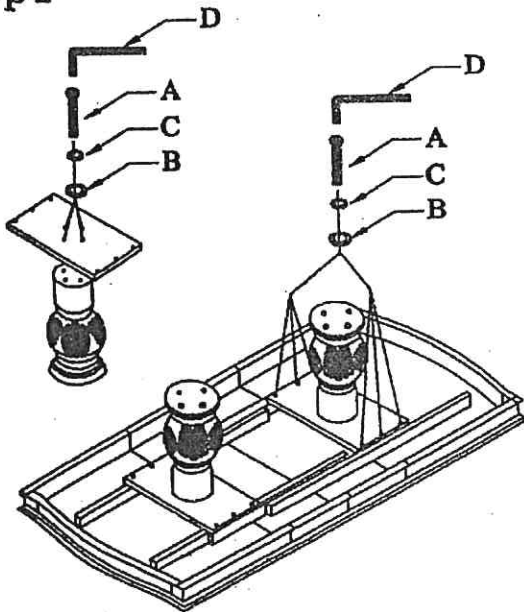



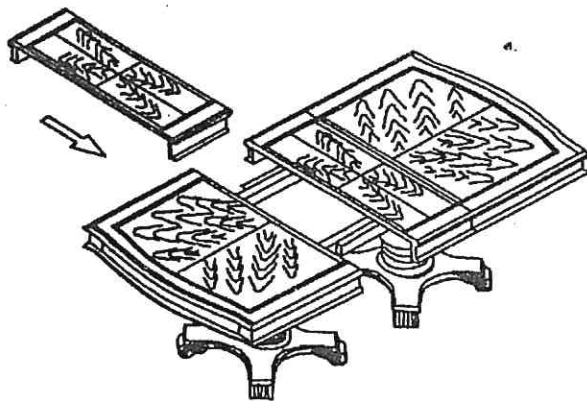
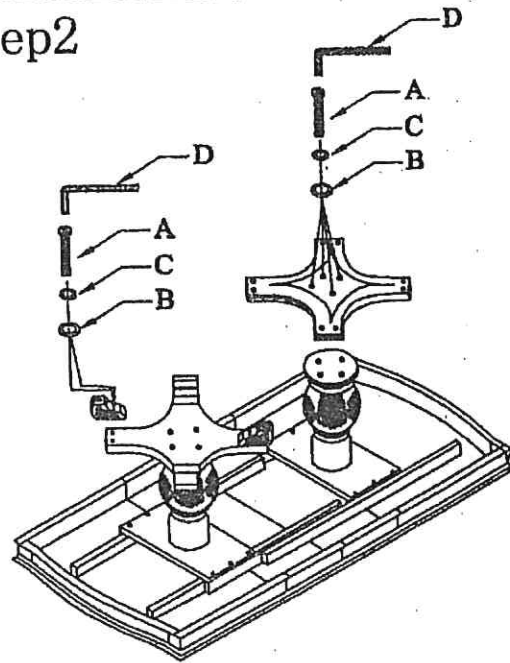

Step2



Finish



Hardware List:

NO.	Description	Drawing	Size	Q'ty
A	Flat Head Bolt		ø5/16"*2"	44
B	Flat Washer		ø5/16"*19mm	44
C	Lock Washer		ø5/16"*12mm	44
D	Allen Wrench		5mm	1