

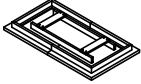







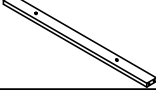

ASSEMBLY INSTRUCTIONS

MODEL : 62330T&62331ST

Important note :

- Place all wooden parts on a clean and smooth surface such as a rug or carpet to avoid scratching the parts.
- Kindly follow the assembly instructions step by step.
- Do not tighten all screws and bolts until the table is fully assembled.

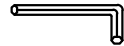
PARTS LIST				HARDWARE LIST			
NO	DESCRIPTION	SRETCH	QTY	NO	DESCRIPTION	SRETCH	QTY
A	TABLE TOP		1 Pc	1	BOLT (BIG)		8 Pcs
B	TABLE LEGS		2 Pcs	2	LONG BOLT (SMALL)		6 Pcs
C	STRETCHER		1 Pc	3	SHORT BOLT (SMALL)		2 Pcs
D	DECORATE LEGS		2 Pcs	4	SPRING WASHER		8 Pcs
E	LEG ACCENT		2 Pcs	5	FLAT WASHER		8 Pcs
F	STRETCHER ACCENT		2 Pcs	6	ALLEN KEY		1 Pc

STEP 1

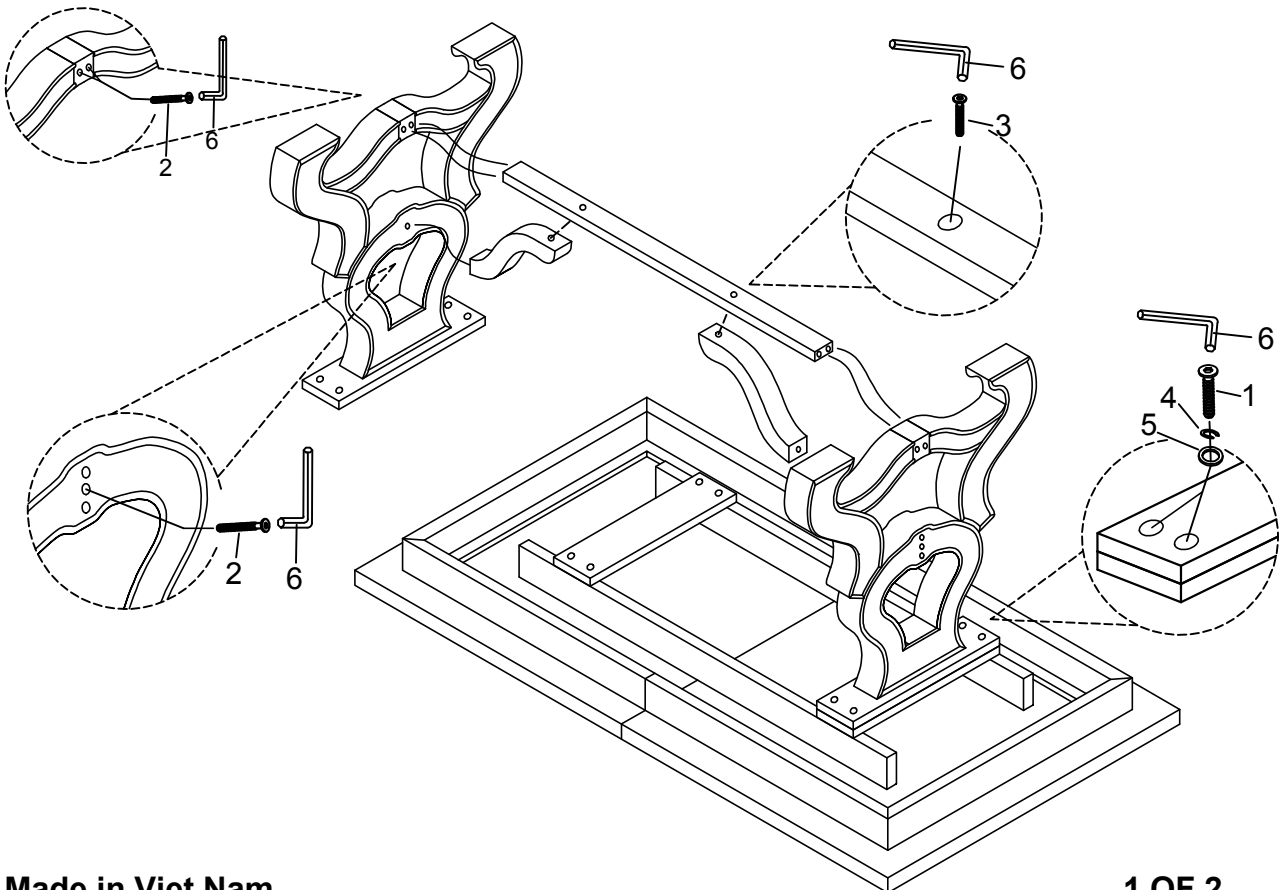

ASSEMBLY INSTRUCTIONS

MODEL : 62330T&62331ST

STEP 2

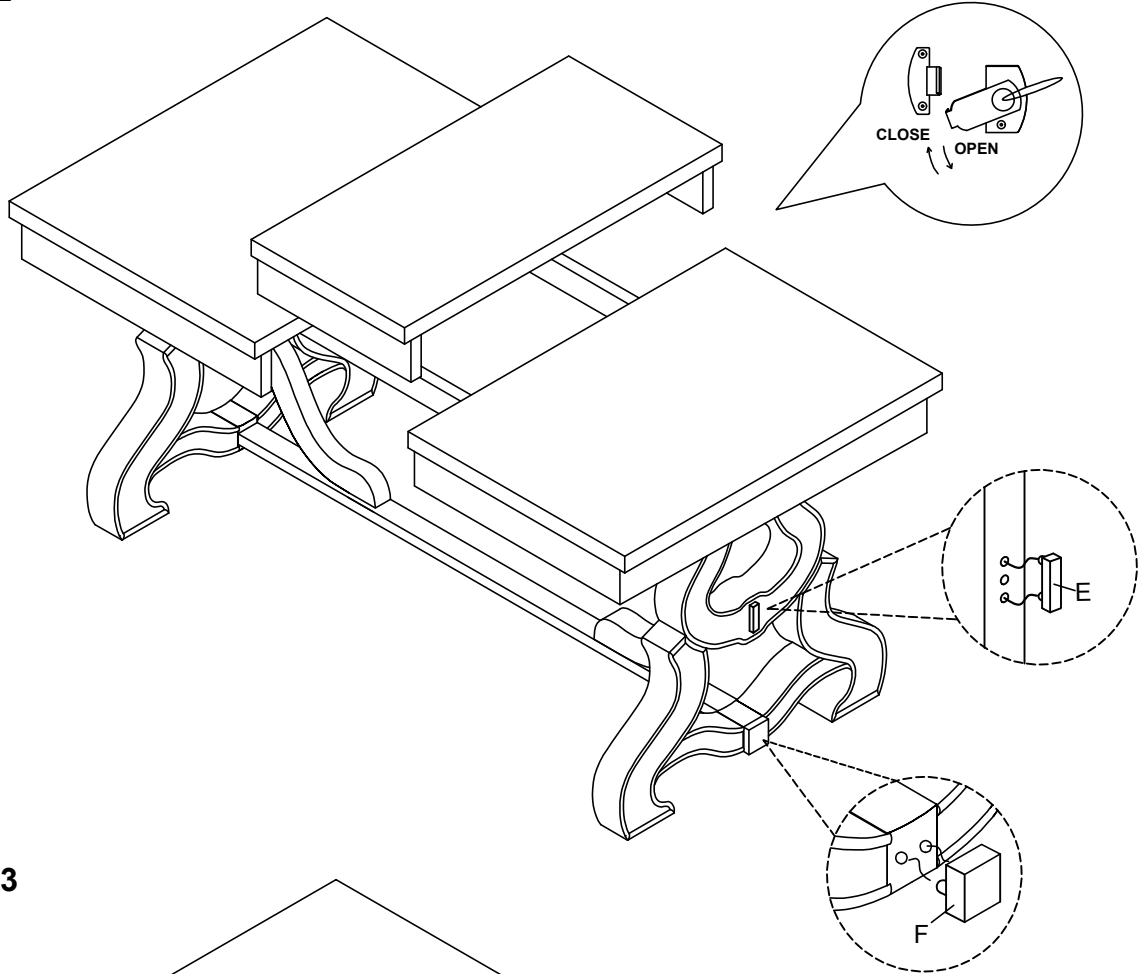

STEP 3

