

R5101/59937

ROCKING CHAIR

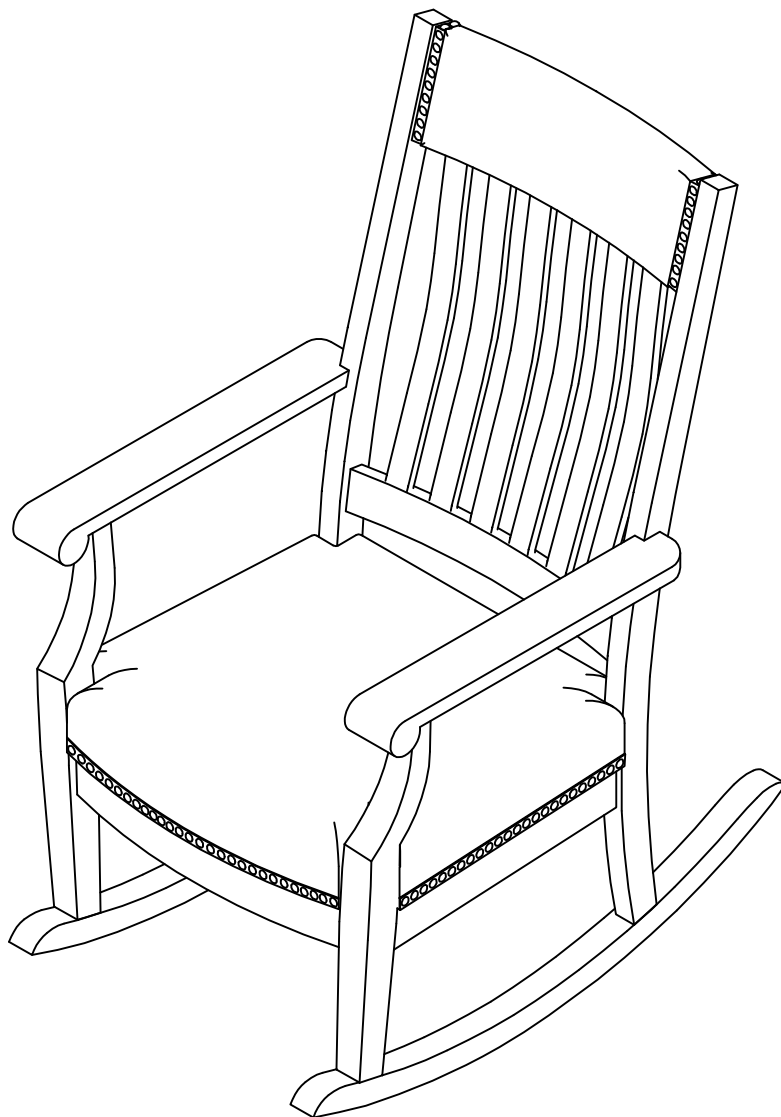

ASSEMBLY INSTRUCTION











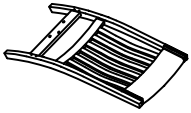



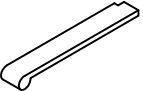

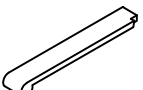

ASSEMBLY TIPS :

- 1 . Remove hardware from box and sort by size .
- 2 . Please check to see that all hardware and parts are present prior start of assembly .
- 3 . Please follow attached instructions in the same sequence as numbered to assure fast & easy assembly .

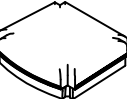

Warning !

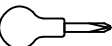
- 1 . Don't attempt to repair or modify parts that are broken or defective . Please contact the seller immediately .
- 2 . This product is for home use only and not intended for commercial establishment .

PARTS LIST				HARDWARES REQUIRED			
1	Ø1/4"x50mm		4pcs	A	Back Chair		1Pc
2	Ø1/4"*10.5mm		4pcs				
3	Ø1/4"*12mm		4pcs				
4	Ø5/16"x75 mm		4pcs	B	Arm (R)		1Pc
5	Ø5/16"x50 mm		4pcs	C	Arm (L)		1Pc
6	Ø5/16"x38 mm		3pcs				
7	Ø5/16"x13mm		11Pcs	D	Front leg (R)		1Pc
8	Ø5/16"x19mm		11Pcs				
9	M4		1Pc	E	Front leg (L)		1Pc
10	M4x38mm		2Pcs	F	Seat		1Pc
11	M3x15mm		4Pcs				
12	Brass plate		2Pcs				
13	Drawer(not included)		1Pc	G	Runner		2Pcs

Step 1

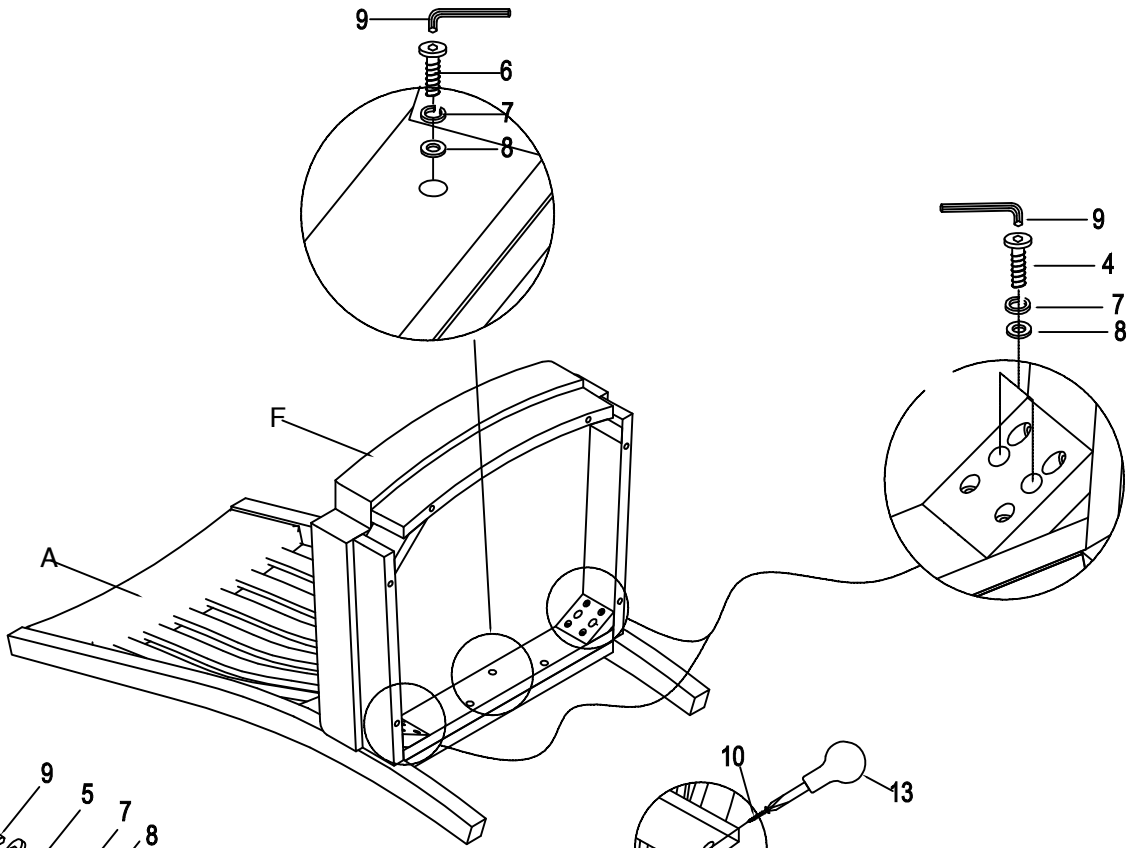

Step 2

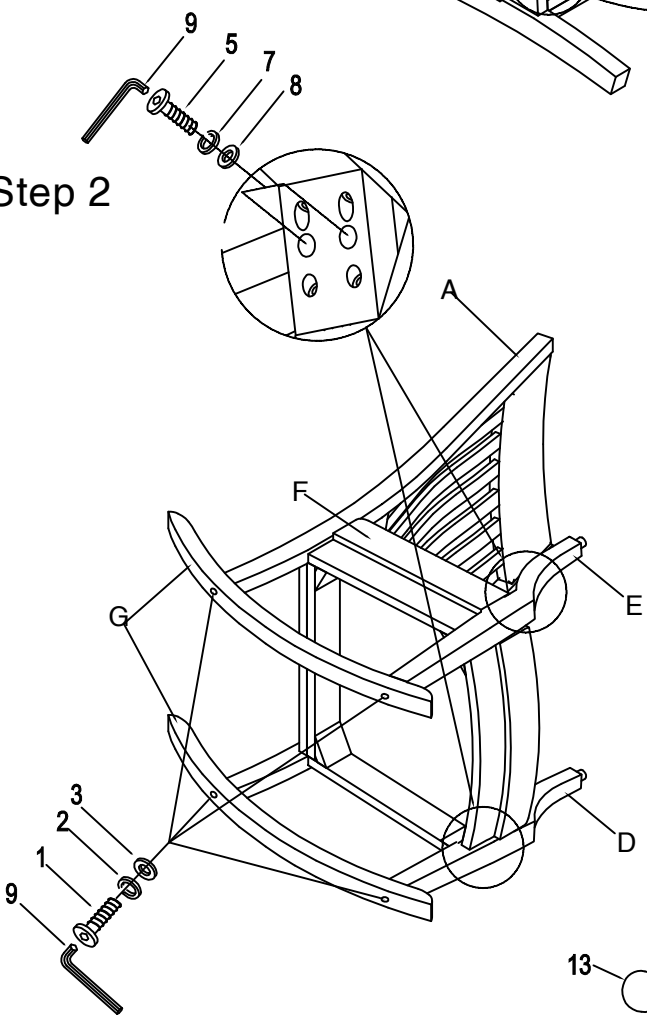

Step 3

