

R3013/59934
ROCKING CHAIR

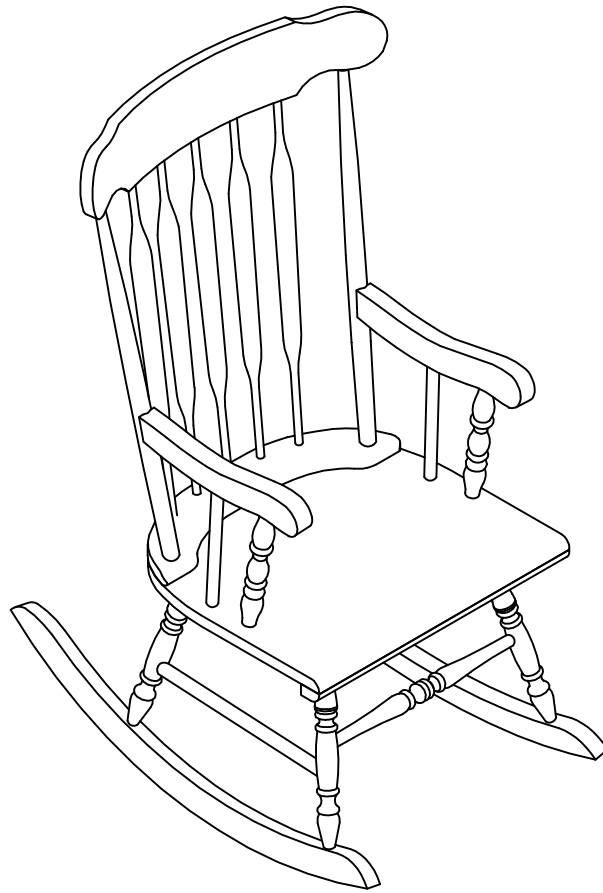

ASSEMBLY INSTRUCTION











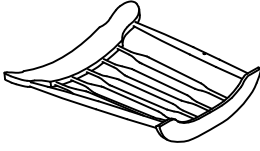

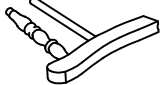

ASSEMBLY TIPS :

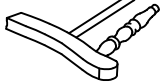
- 1 . Remove hardware from box and sort by size .
- 2 . Please check to see that all hardware and parts are present prior start of assembly .
- 3 . Please follow attached instructions in the same sequence as numbered to assure fast & easy assembly .

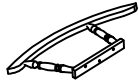
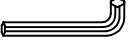

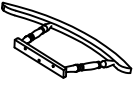
Warning !

- 1 . Don't attempt to repair or modify parts that are broken or defective . Please contact the seller immediately .
- 2 . This product is for home use only and not intended for commercial establishment .

PARTS LIST				HARDWARES REQUIRED			
1	Ø1/4" X 60MM		6pcs	A	Back Chair		1Pc
2	Ø1/4" X 50MM		2pcs				
3	Ø1/4" X 32MM		9pcs				
4	Ø1/4" X 10.5MM		17pcs	B	Arm(L)		1Pc
5	Ø1/4" X 19MM		2pcs	C	Arm(R)		1Pc
6	Ø1/4" X 12.5MM		15pcs				
7	Ø1/4" X 13MM		6Pcs	D	leg (L)		1Pc
8	M4		1Pc				
9	Ø13.5MM X 8MM		6Pcs	E	leg (R)		1Pc
				F	Seat		1Pc
				G	Front Stretcher		1Pc
				H	Back Stretcher		1Pc

STEP 1

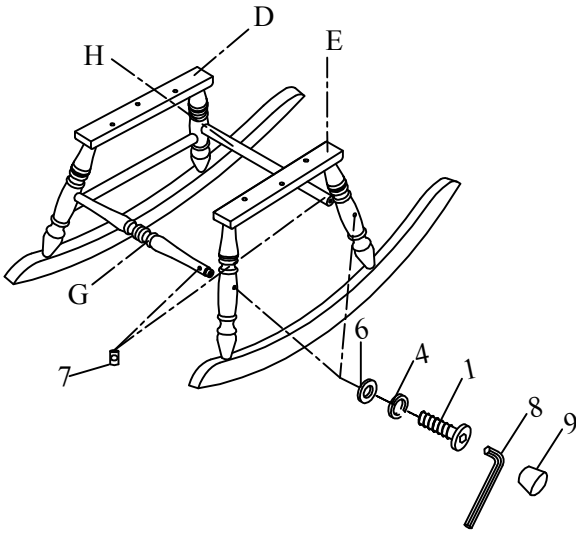

STEP 2

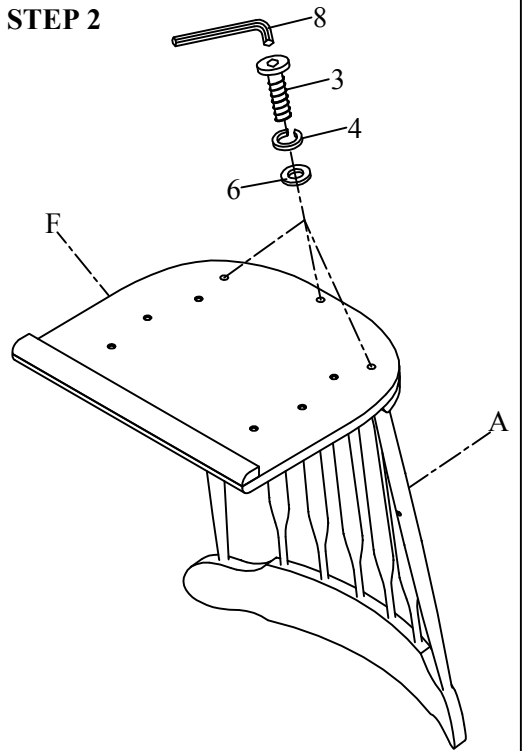

STEP 3

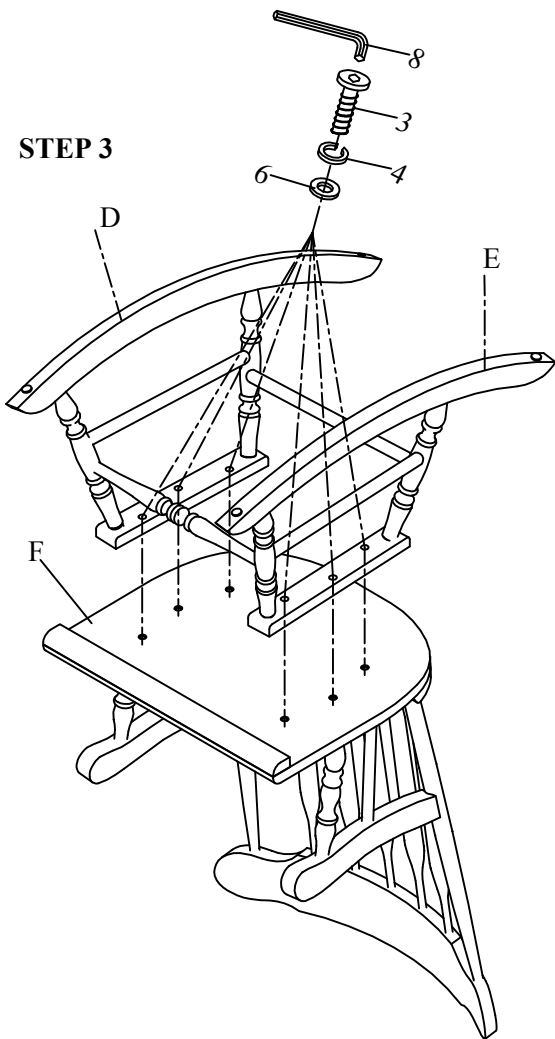

STEP 4

