

59218

YOUTH ROCKER CHAIR

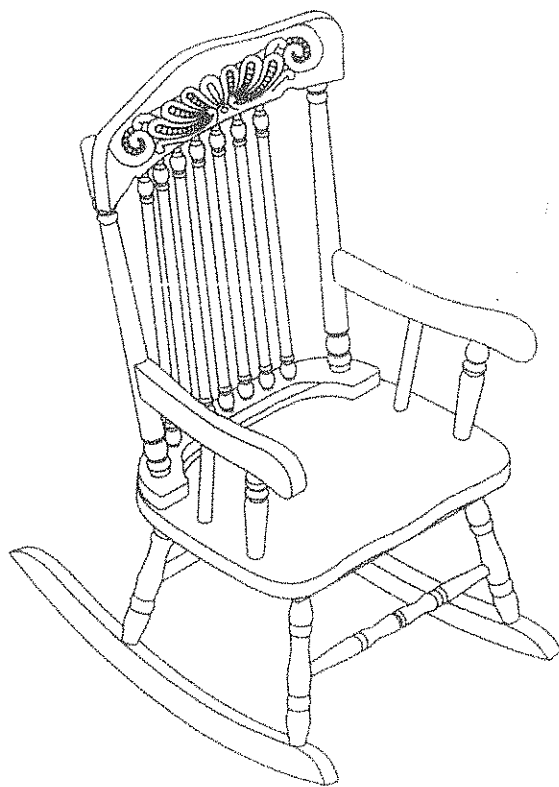

ASSEMBLY INSTRUCTION

ASSEMBLY TIPS :

- 1 . Remove hardware from box and sort by size .
- 2 . Please check to see that all hardware and parts are present prior start of assembly .
- 3 . Please follow attached instructions in the same sequence as numbered to assure fast & easy assembly .











Warning ! 

- 1 . Don't attempt to repair or modify parts that are broken or defective . Please contact the store immediately .
- 2 . This product is for home use only and not intended for commercial establishment .

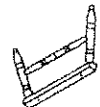
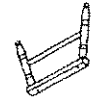
R4802 ROCKER CHAIR

PARTS IDENTIFICATION

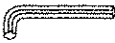
HARDWARE LIST

PARTS IDENTIFICATION	A	CHAIR BACK	1PCS	
		ARM REST (LEFT&RIGHT)	2PCS	
	C	LEG	2PCS	
		CHAIR SEAT	1PC	
	D	FRONT STRETCHER	1PC	
		BACK STRETCHER	1PC	
HARDWARE LIST	1	Ø 3/16" X 32mm	9PCS	
	2	Ø 3/16" x 59mm	2PCS	
	3	Ø 3/16" x 63mm	4PCS	
	4	Ø 3/16" x 18mm	6PCS	
	5	M4	1PC	
	6	Ø 18.5mm x 7mm	5PCS	

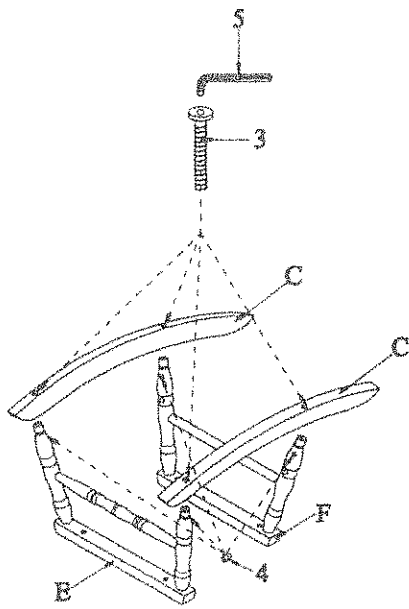

STEP 3

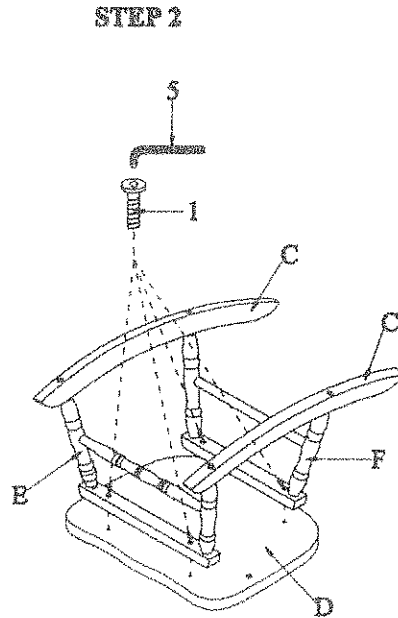

STEP 4

