









# ASSEMBLY INSTRUCTION FOR ACME FURNITURE

## 52115 SOFA

Thank you for purchasing this quality product. Be sure to check all packing material carefully for small parts which may come loose inside the carton during shipment. Identify and count all parts and metal hardware. Compare with the part list to be sure all parts are present, If any part(s) are missing or damage, please contact your local furniture dealer. For efficient and speedy service, please indicate the model number and code letter of part(s) needed.

\*\*Assemble the product on a flat, soft surface such a carpet or cloth to prevent scratching the product finish. Read all instruction and study the drawing carefully before starting the assembly process.

PART LIST			
NO	PART	DECS	QTY
A		sofa	1
B		CENTER LEG	1
C		Rear Leg	2
D		Front leg	2

HARDWARE LIST			
NO	HARDWARE	DECS	QTY
1		BOLT	8PCS
2		LOCK WASHER	8PCS
3		FLAT WASHER	8PC
4		ALLEN WRENCH	1PC

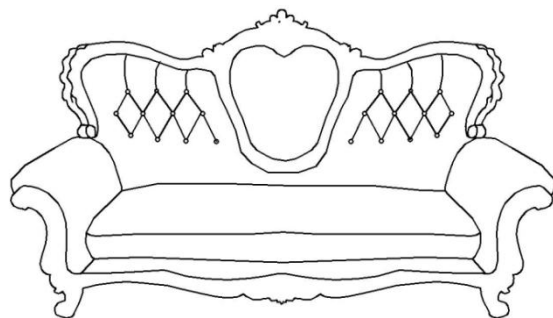
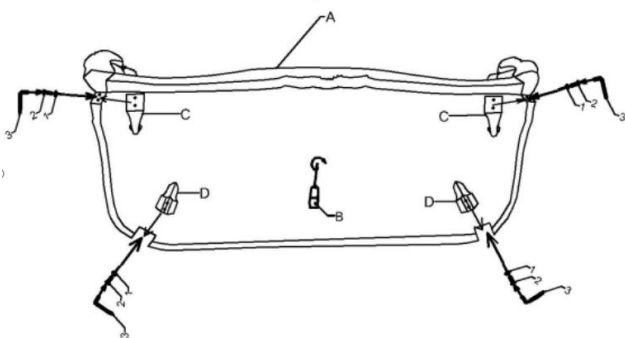

### STEP

1. Turn the SOFA down on a smooth, soft surface to prevent scratching the finish.
2. Attach the leg to the bottom of base as the diagram.
3. Tighten the leg.

\*\*Assembly step 4pcs legs for the SOFA are same as the drawing.

MADE IN CHINA