

# ASSEMBLY INSTRUCTION ITEM NO: 39395HF & 39396PNL













Thank you for purchasing this quality product. Be sure to check all packing material carefully for small parts which may have come loose inside the carton during shipment. Separate, identify and count all parts and hardware. Compare with the parts list to be sure all parts are present.

**"DO NOT TIGHTEN SCREWS UNTIL COMPLETELY ASSEMBLED"**

## IMPORTANT:

PLEASE READ INSTRUCTION BEFORE STARTING THE ASSEMBLY

HARDWARE LIST				
ITEM	DESCRIPTION	DRAWING	SIZE	QTY
A	JCBB SCREW		M8 X 20MM	16PCS
B	JCBC SCREW		M6 X 50MM	20PCS
C	SPRING WASHER		M6 X 13MM	16PCS
D	FLAT WASHER		M6 X 19MM	4PCS
E	FLAT WASHER		M6 X 13MM	12PCS
F	SCREW		M4 X 32MM	16PCS
G	SCREW		M4 X 16MM	24PCS
H	L - KEY		M4 X 65MM	1PC
I	L - KEY		M5 X 65MM	1PC

PART LIST			
ITEM	DESCRIPTION	DRAWING	QTY
1	BACK REST		1PC
2	LEFT ARM		1PC
3	RIGHT ARM		1PC
4	FRONT SIDE RAIL		1PC
5	BACK SIDE RAIL		1PC
6	LEGS		4PCS
7	DAYBED SLAT	 7PCS	2 SETS
8	TRUNDLE FRONT RAIL		1PC
9	TRUNDLE BACK RAIL		1PC
10	TRUNDLE SIDE RAIL		2PCS
11	SUPPORT SLAT		3PCS
12	TRUNDLE SLAT	 5PCS	2 SETS
13	CASTORS		6PCS

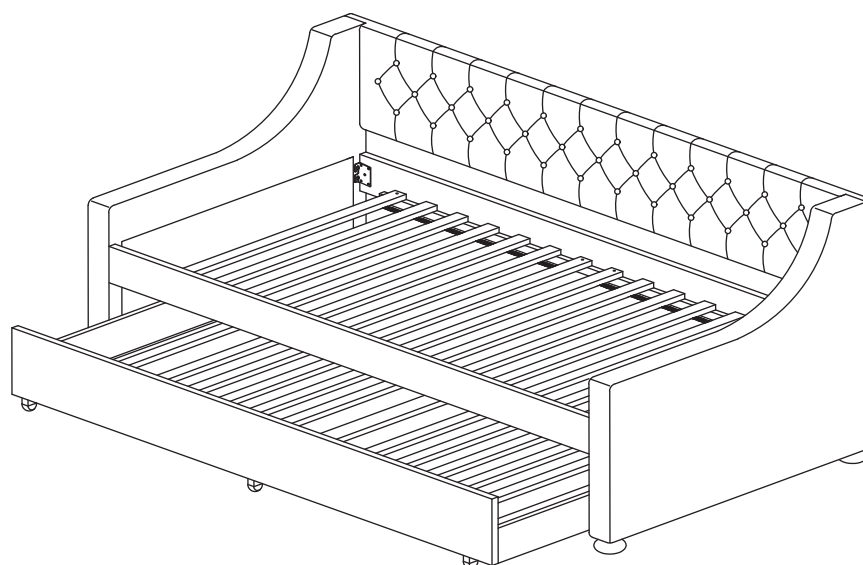

# ASSEMBLY INSTRUCTION

ITEM NO : 39395HF & 39396PNL

STEP 1

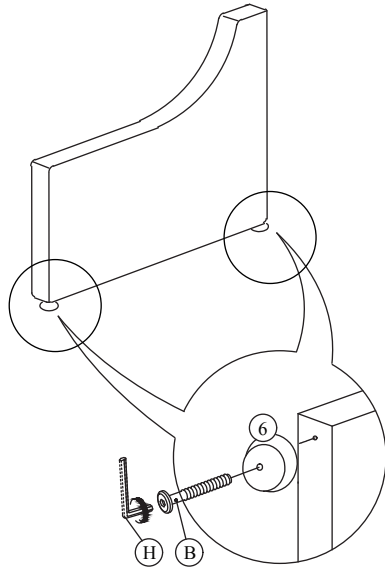

STEP 2

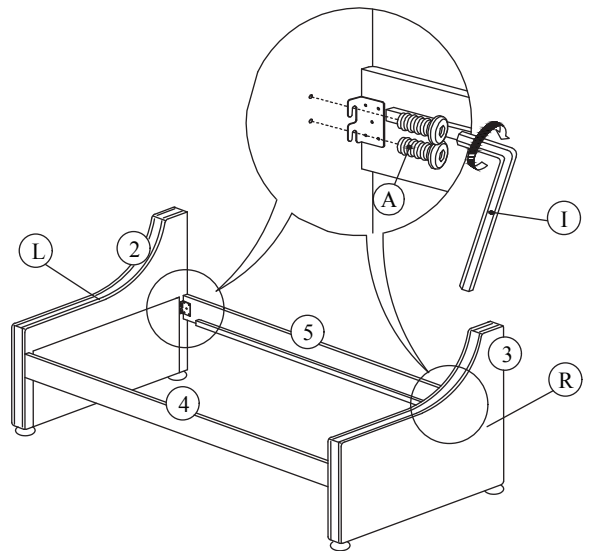

STEP 3

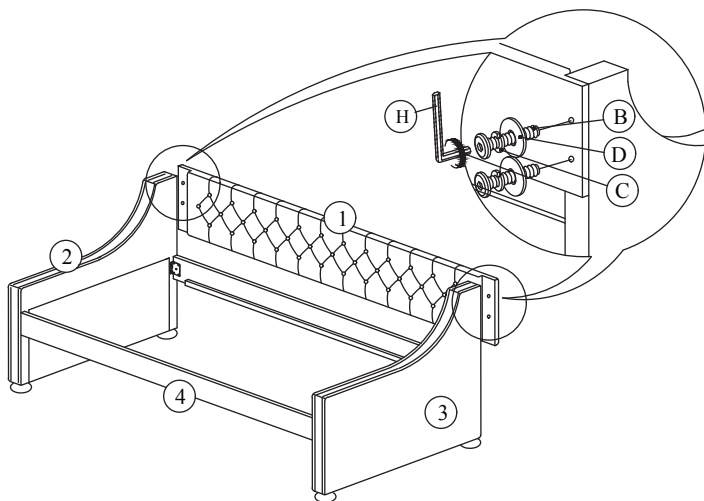

STEP 4

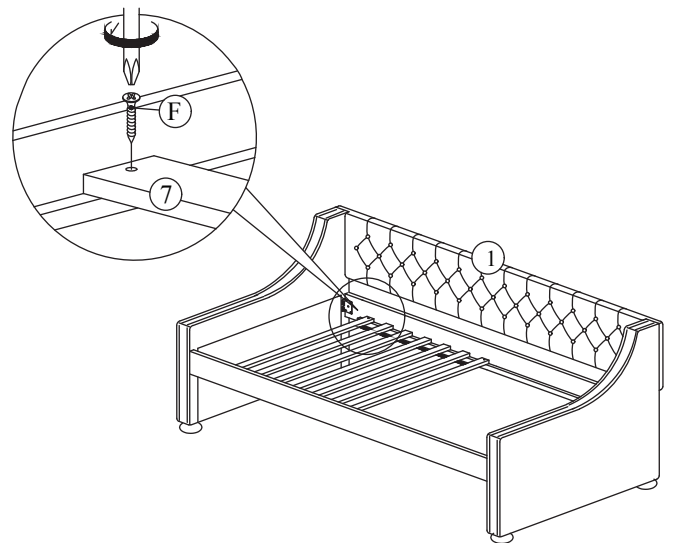

STEP 5

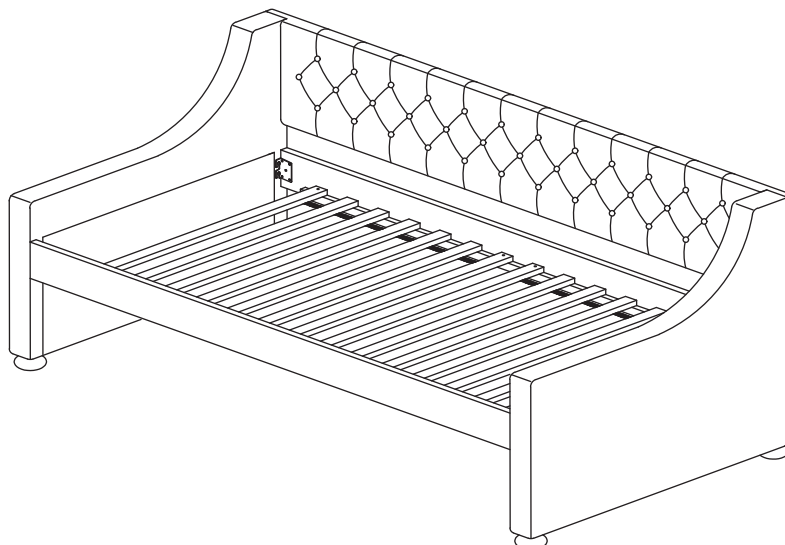

# ASSEMBLY INSTRUCTION

ITEM NO : 39395HF & 39396PNL

STEP 6

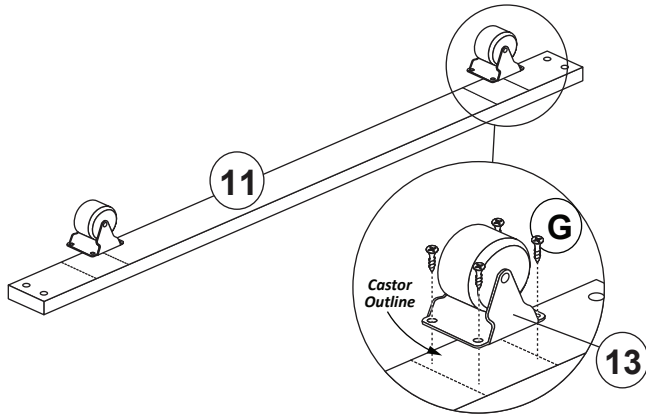

STEP 7

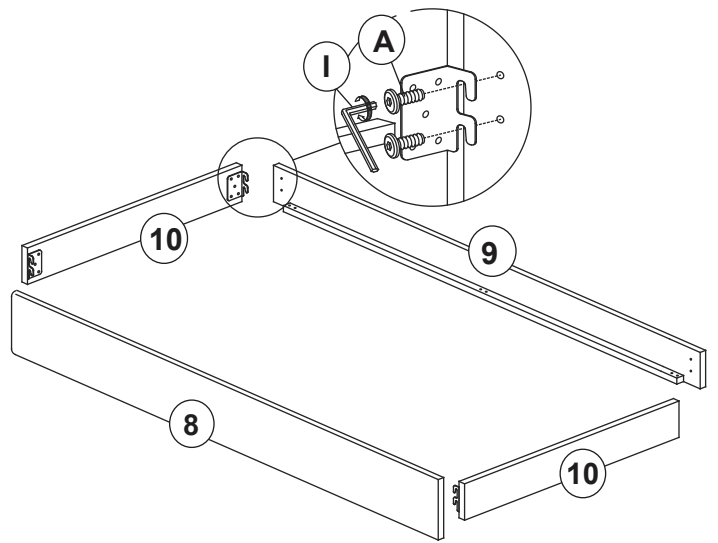

STEP 8

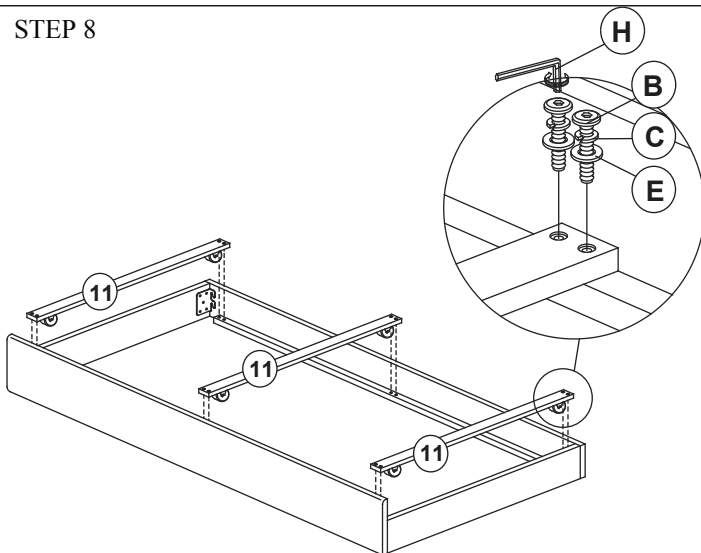

STEP 9

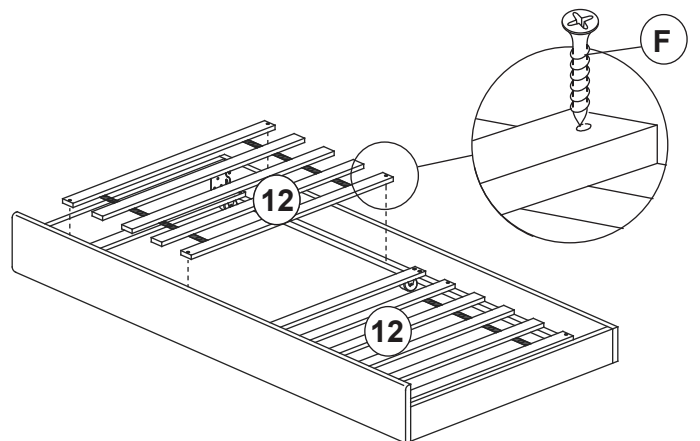

STEP 10

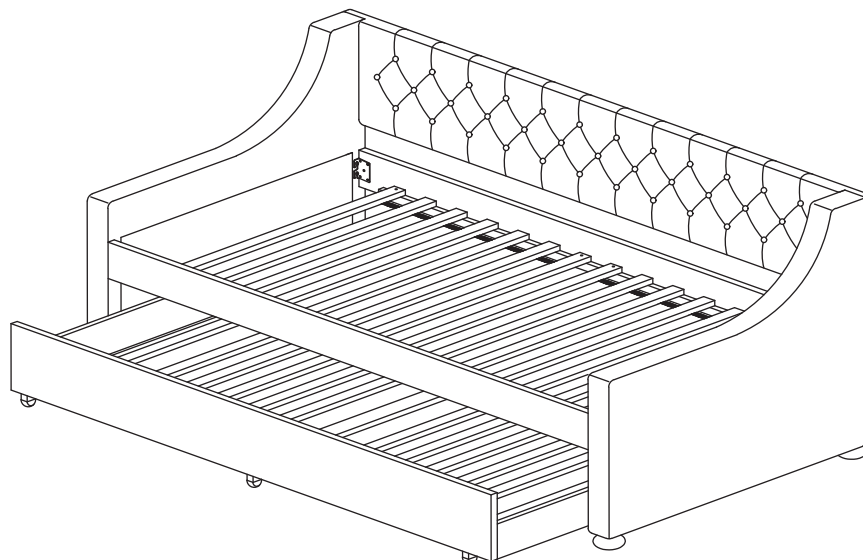

ASSEMBLY  
COMPLETED