

**ACME
FURNITURE**

ASSEMBLY INSTRUCTIONS

Item No: 30765 & 30764

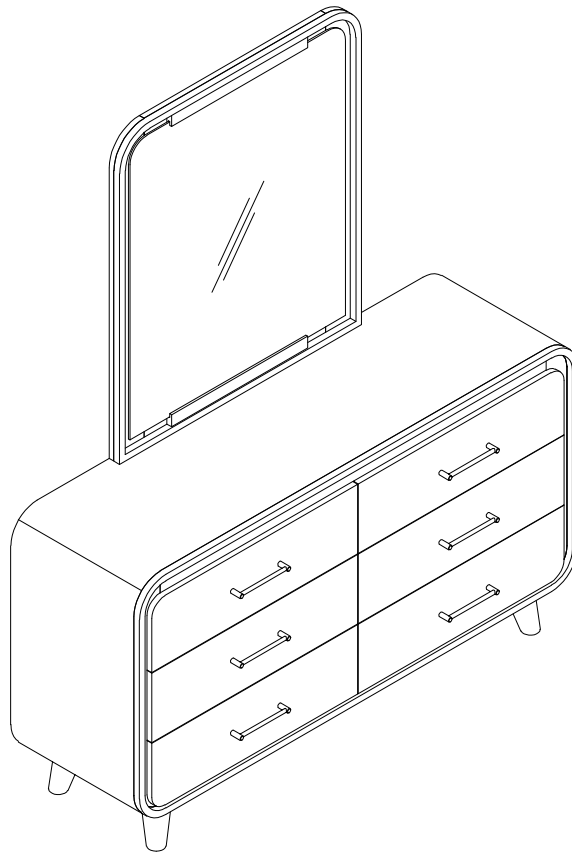

*** Thank you for purchasing this quality product. Be sure to check all packing materials carefully for small parts which may have come loose inside the carton during shipment. Identify and count all parts and compare with parts list below.

*** Assemble product on a flat, soft surface such as a carpet or cloth to prevent scratching the finish. Read all instruction and study the drawings carefully before starting the assembly process.







IMPORTANT: Do not tighten bolts completely until all bolts are completely lined up and inserted into holes



PARTS LIST

No	DIAGRAM	PART NAME	Q'Ty
1		Dresser	1 pc
2		Mirror	1 pc
3		Mirror Support	2 pcs

HARDWARE LIST

No	DIAGRAM	PART NAME	Q'Ty
A		Bolt: Ø1/4" * 1-3/8"	8 pcs
B		Flat Washer: Ø1/4"	8 pcs
C		Spring washer: Ø1/4"	8 pcs
D		Allen Wrench (M4)	1 pc

STEP 1:

A		8 pcs
B		8 pcs
C		8 pcs

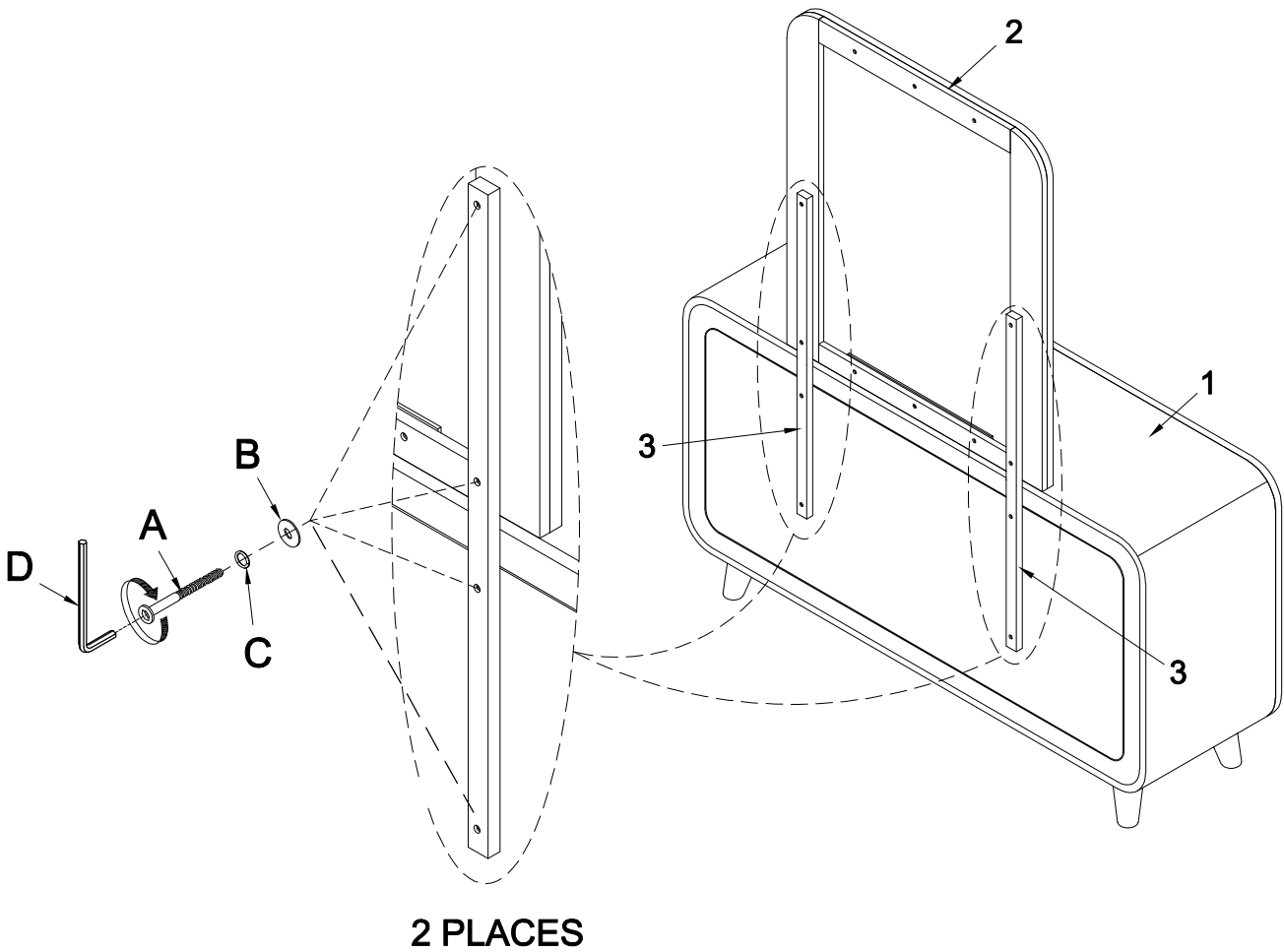

STEP 2:

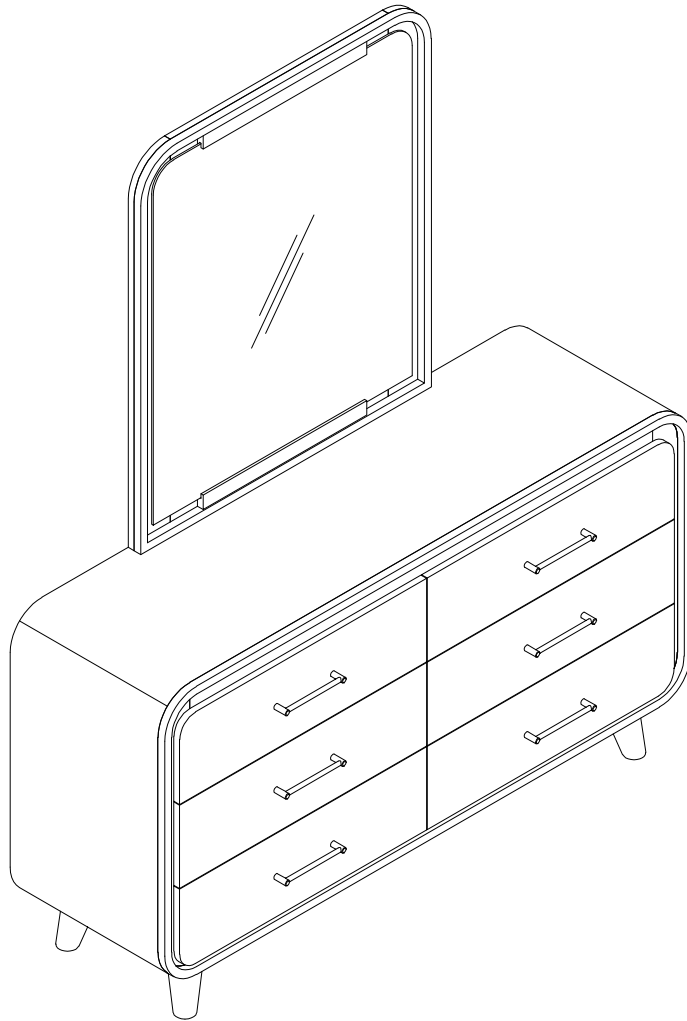

ASSEMBLY IS COMPLETED