

**ASSEMBLY INSTRUCTIONS**  
**ITEM NO.:50539**

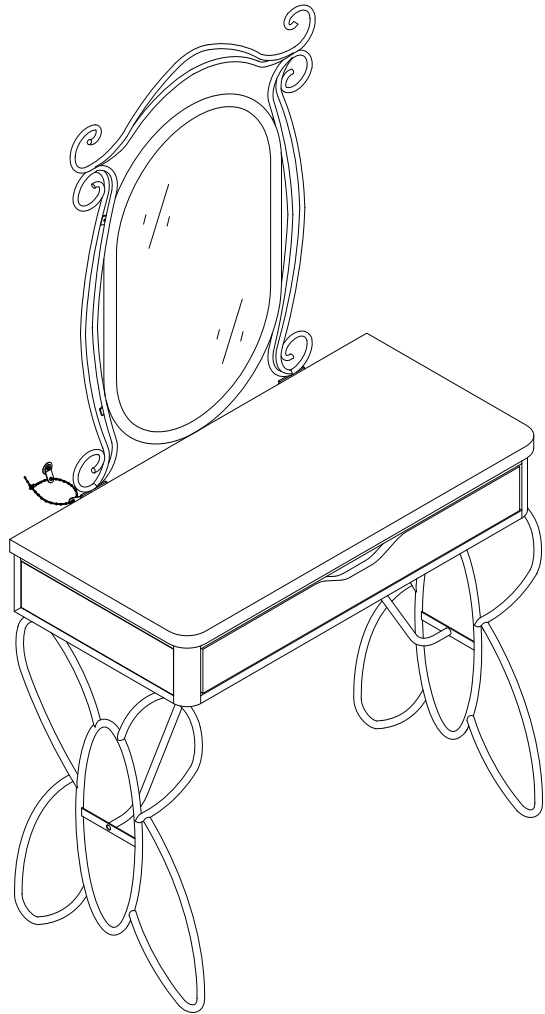

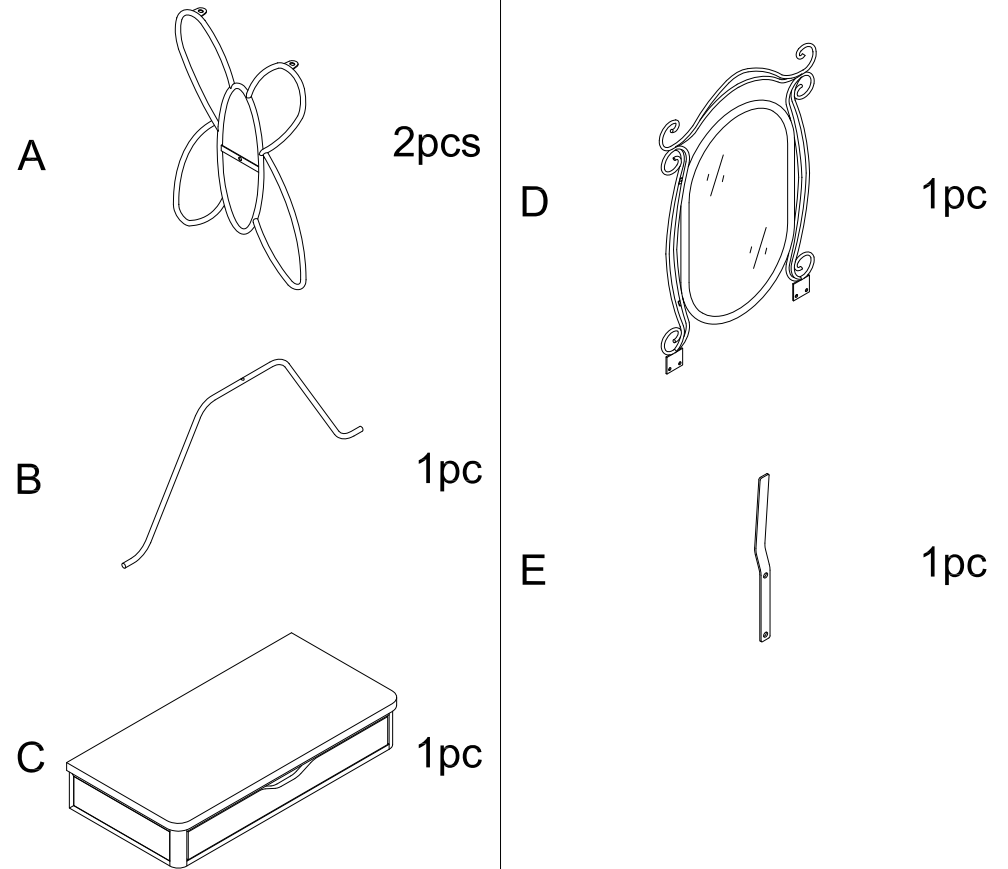





**Do not tighten screws until completely assembled.**

**PARTS IDENTIFICATION**



**HARDWARE LIST**

1		8pcs	M6x15	2		5pcs	M6x20	3		1pc	4x4
4		1pc	M4x37	5		2pcs		6		1pc	
7		1pc									

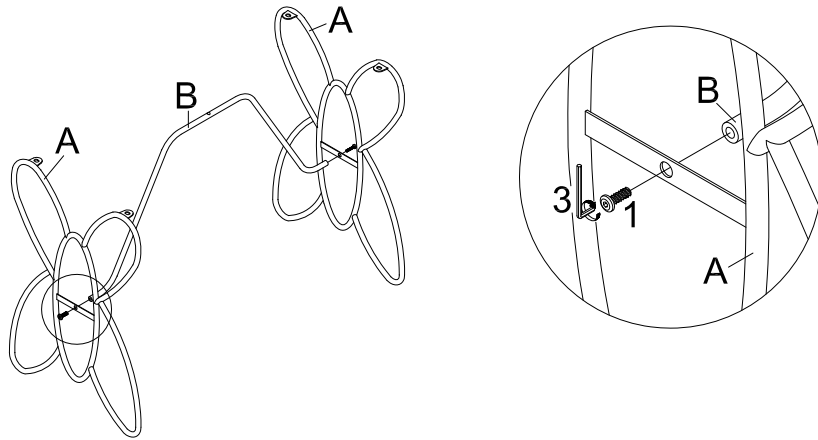

STEP 1.



1		2pcs
M6x15		

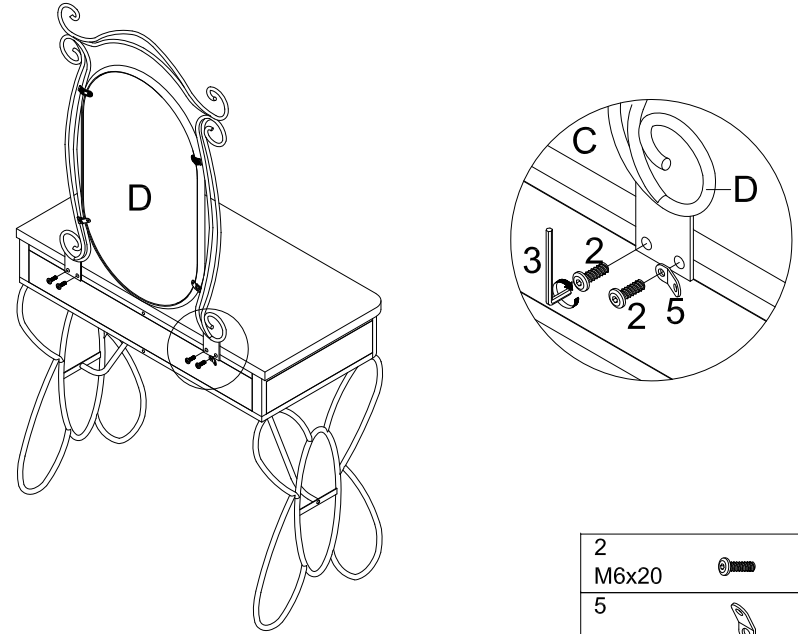

STEP 3.

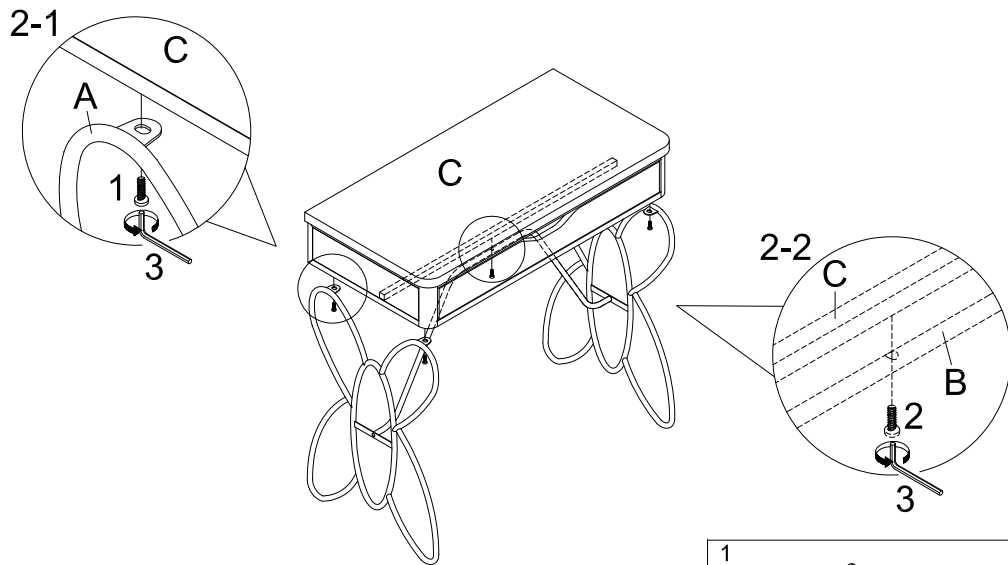

2		4pcs
M6x20		
5		1pc

STEP 2.



1		4pcs
M6x15		
2		1pc
M6x20		

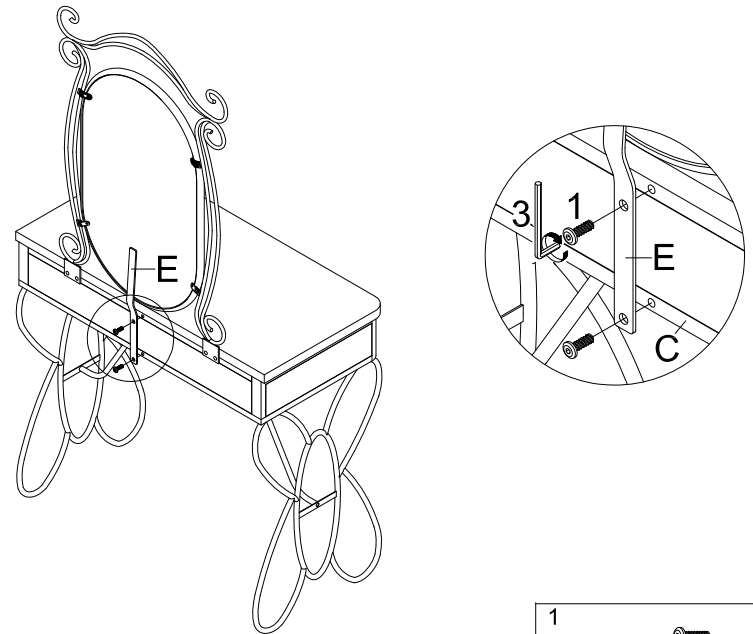

STEP 4.

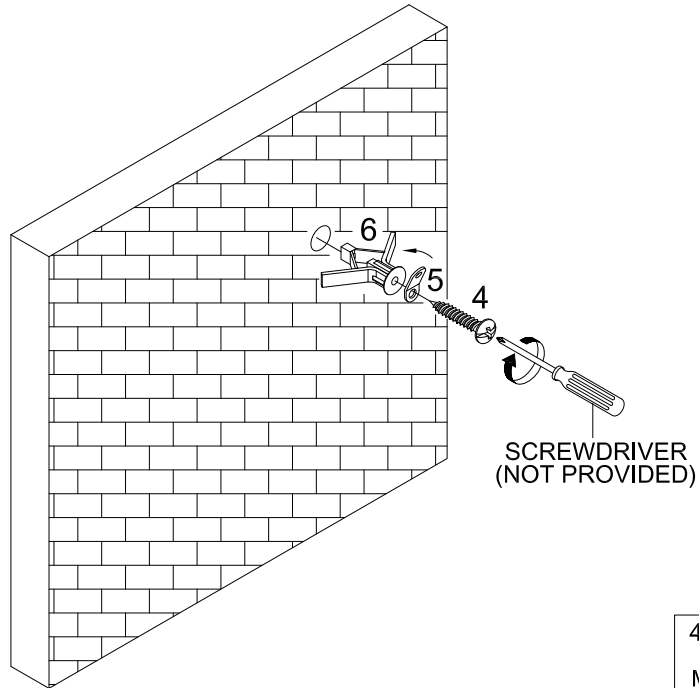

1		2pcs
M6x15		

# STEP 5.



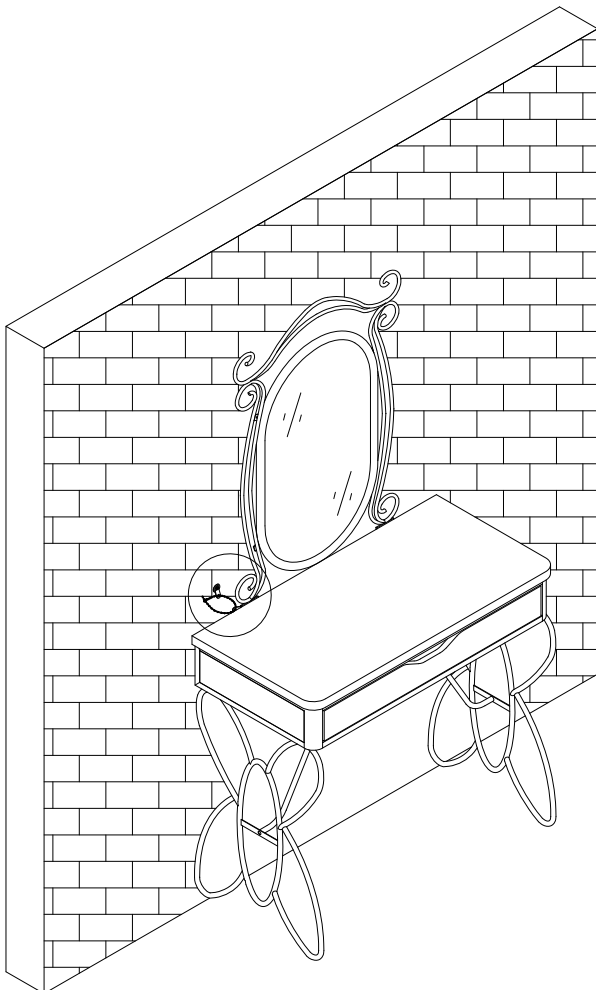

4		1pc
5		1pc
6		1pc

# STEP 6.

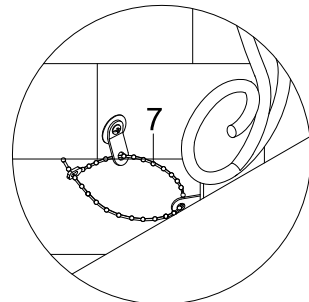

To Prevent Tip over  
Product Must Be  
Attached To Wall



7		1pc
---	---	-----

# ASSEMBLY INSTRUCTIONS

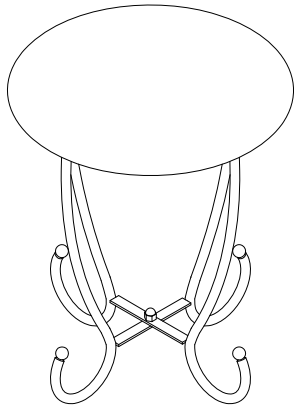

ITEM NO.: 30539



**Do not tighten screws until completely assembled.**

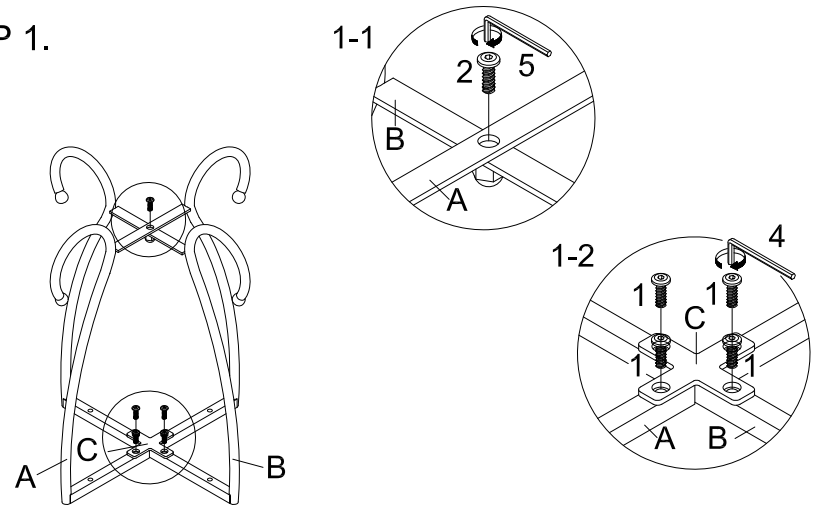

## STEP 1.





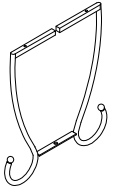
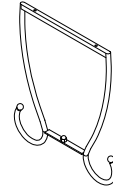

1		4pcs
M6x12		
2		1pc
M8x15		

## PARTS IDENTIFICATION

## HARDWARE LIST

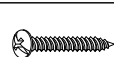
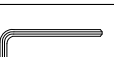
A		1pc
B		1pc
C		1pc
D		1pc

1		4pcs
M6x12		
2		1pc
M8x15		
3		4pcs
M5x25		
4		1pc
4x4		
5		1pc
5x5		

## STEP 2.

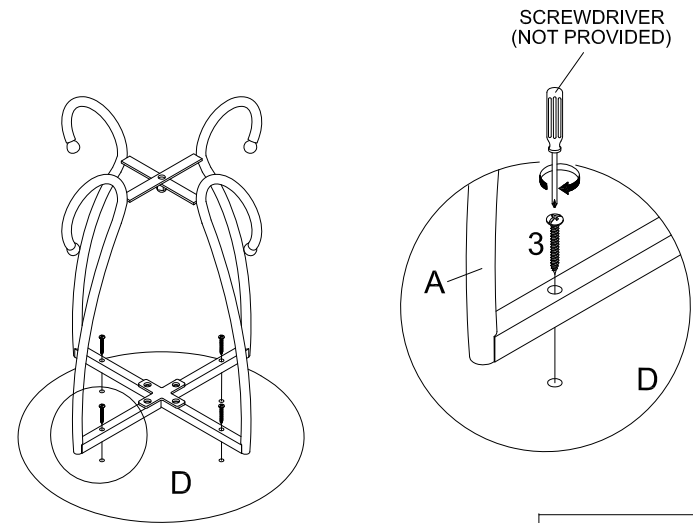

3		4pcs
M5x25		