

ASSEMBLY INSTRUCTION

Item No.: 30538

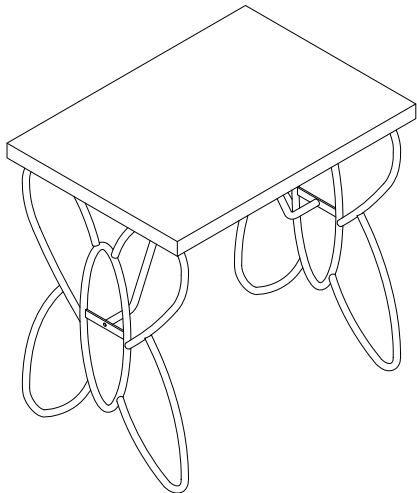

Do not tighten screws until completely assembled.

STEP 1.

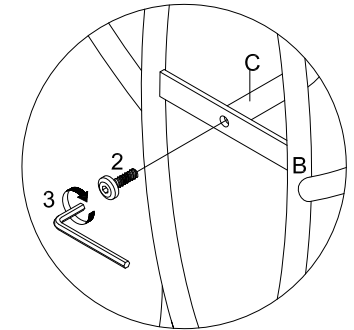
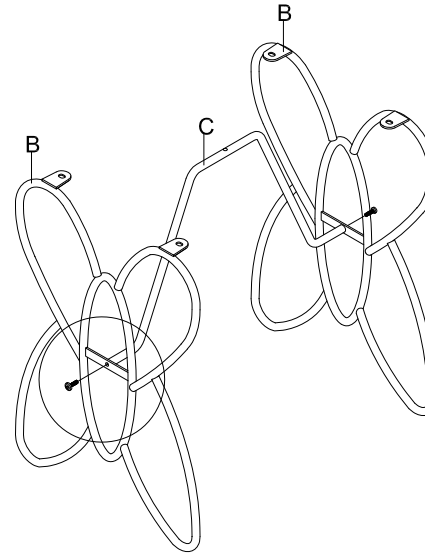

2		2pcs
M6x20		

PARTS IDENTIFICATION

HARDWARE LIST

A

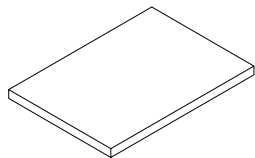

1pc

B





2pcs

C





1pc

1		4pcs
M6x10		
2		3pcs
M6x20		
3		1pc
4x4		

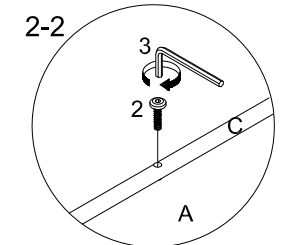
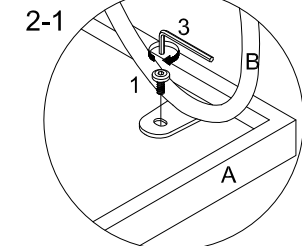
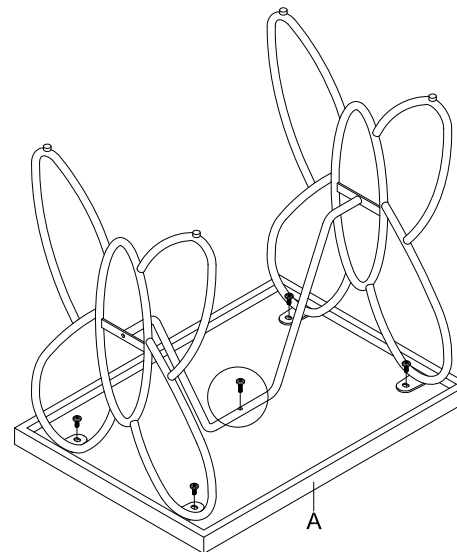
STEP 2.



1		4pcs
M6x10		
2		1pc
M6x20		