









# ASSEMBLY INSTRUCTION

ITEM NO. :26108CK-EK-HB/26109CK-EK-FB/26104CK-R

Thank you for purchasing this quality product. Be sure to check all packing material carefully for small parts which may have come loose inside the carton during shipment. Separate, identify and count all parts and hardware. Compare with the parts list to be sure all parts are present. "DO NOT TIGHTEN SCREWS UNTIL COMPLETELY ASSEMBLED"

IMPORTANT:  
PLEASE READ INSTRUCTION BEFORE STARTING THE ASSEMBLY

#### Hardware List

NO.	Description	Drawing	Size	Qty
1	Flat Head Bolt		Ø5/16"x45mm	8
2	Flat Washer		Ø5/16"x19x2mm	8
3	Spring Washer		Ø5/16"	8
4	Allen Key		4mm	1
5	Hanger Bolt		Φ5/16*82mm	8
6	"C" Washer		Ø5/16**35*14mm	8
7	Nut		Φ5/16*12*18mm	8
8	Wrench		12mm	1
9	Screw		#8*25mm	8

## Step 3

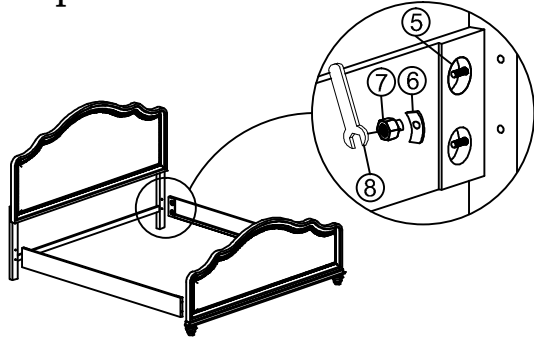

## Step 4

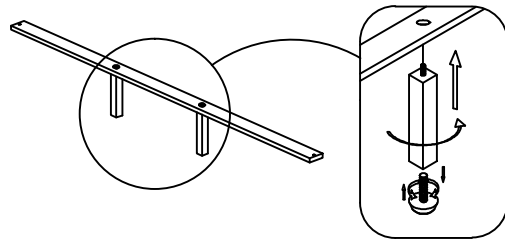

## Step 1

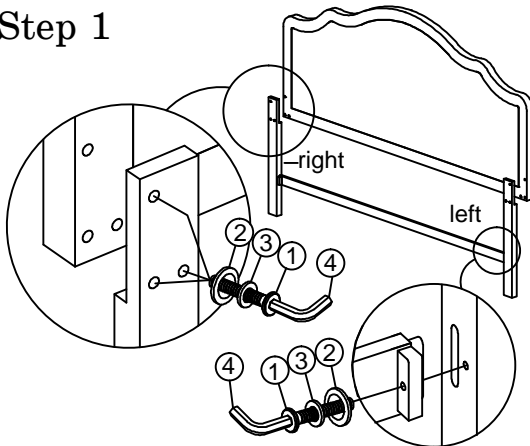

## Step 5

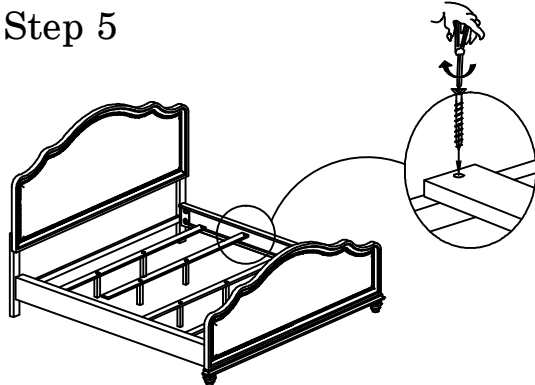

## Step 2

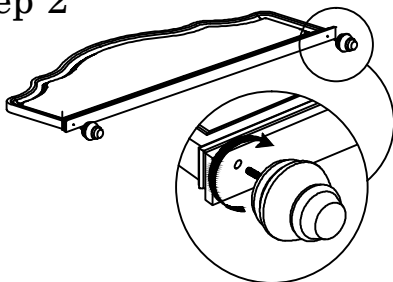

## Finish

