

ASSEMBLY INSTRUCTION



ITEM: ACME#26050Q-HB



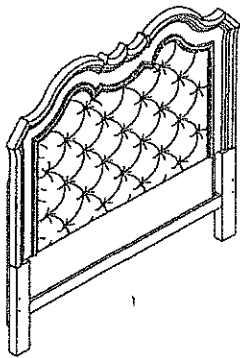

DESCRIPTION: QUEEN HEADBOARD

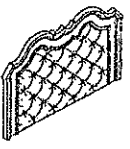
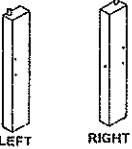
Thank you for purchasing this quality product. Be sure to check all packing materials carefully for small parts, which may have come loose inside the carton during shipment. Identify and count all parts and compare with the parts list below.

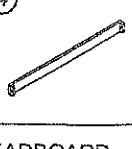
PARTS LIST:



 1	 2 LEFT RIGHT	 3	 4
HEADBOARD: 1PC	POST-LEGS: 2PCS	WOOD SUPPORT : 2PCS	HEADBOARD SLAT: 1PC

HARDWARE LIST			
NO.	Drawing	Description	Q'ty
A		Bolt (Ø5/16"x2")	10pcs
B		Bolt (Ø5/16"x1-3/4")	2pcs
C		Flat washer (Ø5/16"x19mm)	12pcs
D		Spring washer (Ø5/16")	12pcs
E		Ø5/16" Wrench(12mm)	1pc

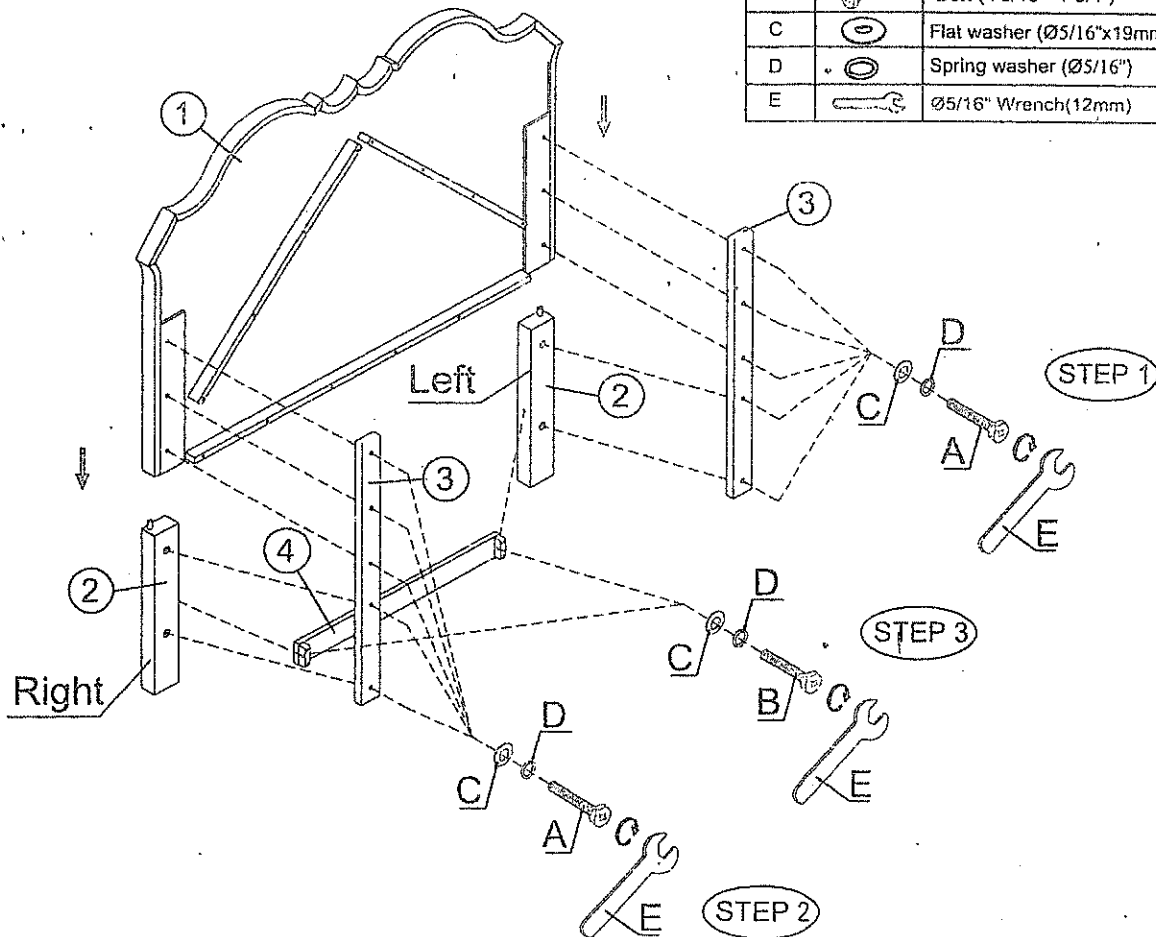

CLEANING INSTRUCTION

Clean the Queen headboard surface with a furniture polish and a soft cloth.

Made in Vietnam