

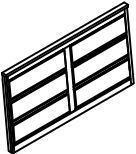

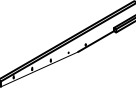





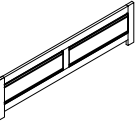
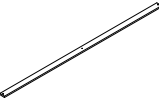

# ASSEMBLY INSTRUCTION

MODEL : FBQHFk-061C + FBQSRR-061A  
 REVISION : A

NO	PART & HARDWARE LIST IN HEADBOARD & FOOTBOARD	QTY.
A	HEADBOARD 	1PC
B	LEG ( LEFT ) 	2PCS
C	LEG ( RIGHT ) 	2PCS
D	FOOTBOARD 	1PC
E	SLAT 	4PCS
F	SLAT SUPPORT 	4PCS
G	JCBC M6 X 35mm 	6PCS
H	SPRING WASHER Ø1/4" 	6PCS
I	FLAT WASHER Ø1/4" x 20mm 	6PCS
J	WOOD DOWEL M10 x 35mm 	4PCS
K	CSK SCREW M4 X 32mm 	8PCS
L	L KEY M4 	1PC
M	L KEY M5 	1PC

## STEP 1

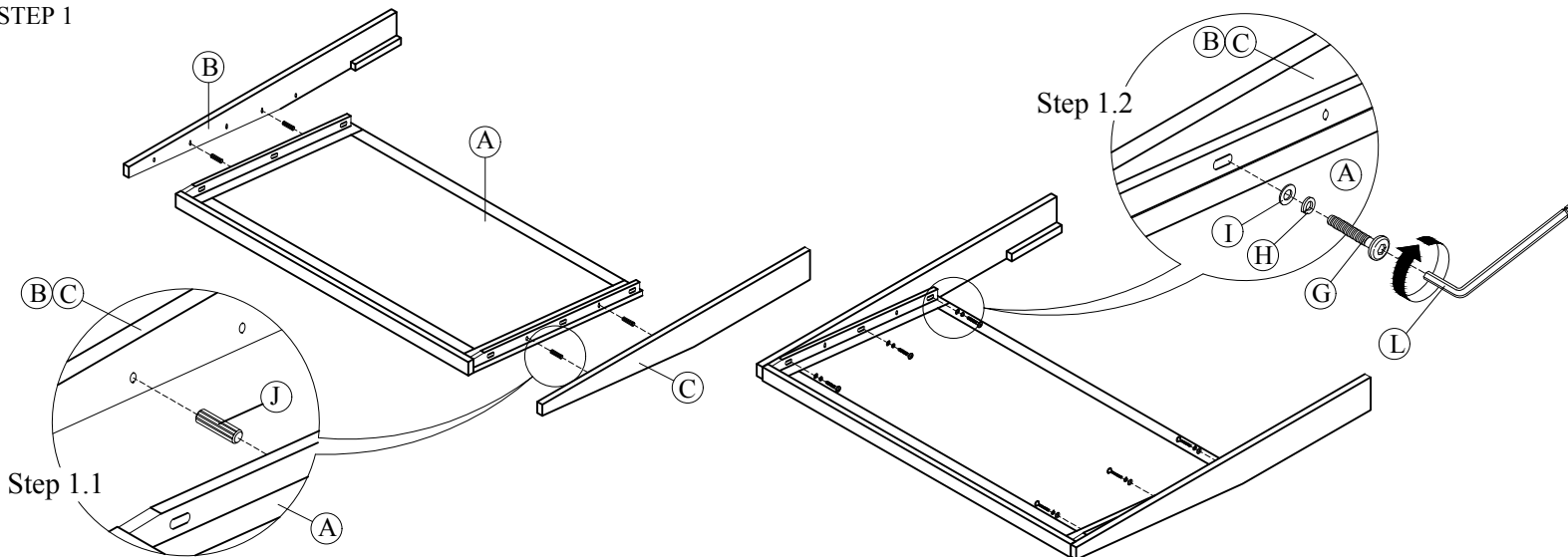

ASSEMBLY COMPLETED !

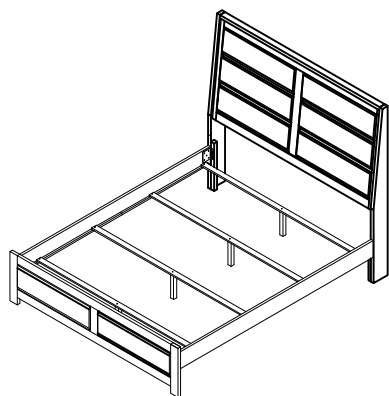

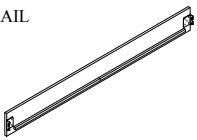
NO	PART LIST IN SIDERAIL	QTY.
N	SIDERAIL 	2PCS

## STEP 2

